

## SCHWIMMBADKUGELHÄHNE PVC / TYP EURO CEPEX

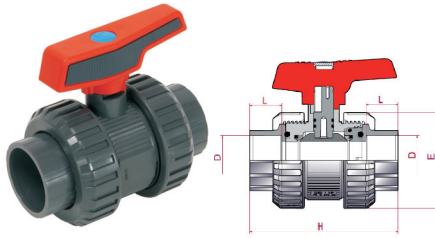

**Klebeanschluss- beidseitig gesichert!**  
**Dichtung KLEBE/CR, O-Ring EPDM**  
 Temperaturbeständig bis 60°



D	Art.-Nr.	DN	PN	L	H	E	VE	Preis
20	436501	15	16	16	87	50	24	
25	436502	20	16	19	101	61	10	
32	436503	25	16	22	122	70	8	
40	436504	32	16	26	135	81	6	
50	436505	40	16	31	149	96	10	
63	436506	50	16	38	174	118	10	
75*)	436507	65	16	44	216	146	4	
90*)	436508	80	16	51	256	176	1	
110*)	436509	100	16	63	359	228	1	

\*)PN 10 = PN 1,0 Mpa

**beidseitig gesichert!**

**Industrierausführung auf Anfrage!**

## SCHWIMMBADKUGELHÄHNE PVC / TYP STANDARD CEPEX

**Klebeanschluss-**  
**Dichtung HDPE/CR, O-Ring EPDM**  
 Temperaturbeständig bis 60°

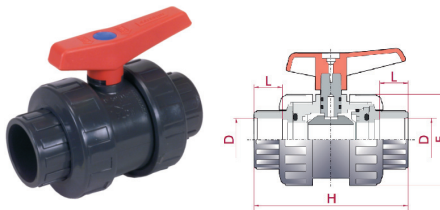

D	Art.-Nr.	DN	PN	L	H	E	VE	Preis
16	04099	15	16	16	84	52	12	
20	04100	15	16	16	84	52	12	
25	04101	20	16	19	108	62	6	
32	04102	25	16	22	124	70	8	
40	04103	32	16	26	142	84	6	
50	04104	40	16	31	167	104	6	
63	04105	50	16	38	198	120	9	
75*)	04106	65	10	44	232	148	1	
90*)	04107	80	10	51	269	179	1	
110*)	04108	80	10	61	275	179	1	

\*)PN 10 = PN 1,0 Mpa

## SCHWIMMBADKUGELHÄHNE PVC / CEPEX

**Klebeanschluss-**  
**Dichtung HDPE/CR, O-Ring EPDM**  
 Temperaturbeständig bis 60°

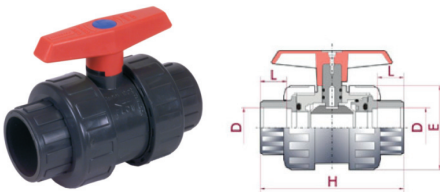

D	Art.-Nr.	DN	PN	L	H	E	VE	Preis
50	04134	40	10	31	162	94	10	
63	04135	50	10	38	192	117	10	

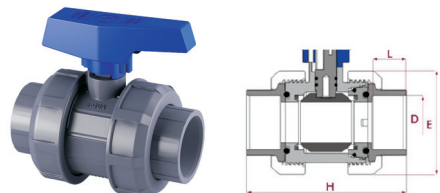

50	441544	40	12	31	149	96	10	
63	441545	50	12	38	174	118	10	

**beidseitig gesichert!**

**Klebenippel und Tülle / Tülle**  
**Dichtung HDPE, O-Ring EPDM**  
 Temperaturbeständig bis 90°



DN	VE	Art.-Nr.	DA	Preis
32	16	04136	40 x Tülle	
40 x 40	16	04137	Tülle x Tülle	



**ERSATZTEILE SCHWIMMBADKUGELHÄHNE PN 16 /12 TYP EURO CEPEX**

**€ Gruppe A**  
exkl. MWSt.

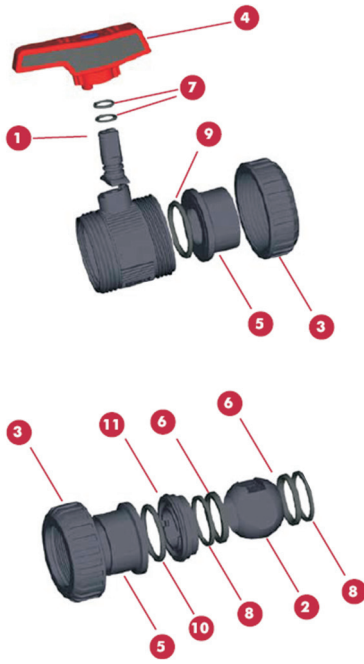

PN16/12

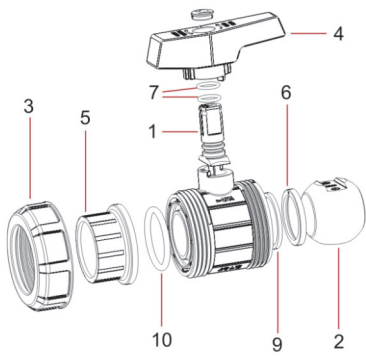

PN12

Bezeichnung	DA	TL	Ref.-Nr.	Art.-Nr.	Preis
Üw.-Mutter für	16/20	3	(36501R0104)	<b>4365011</b>	
Üw.-Mutter für	25	3	(36502R0104)	<b>4365021</b>	
Üw.-Mutter für	32	3	(36503R0104)	<b>4365031</b>	
Üw.-Mutter für	40	3	(36504R0104)	<b>4365041</b>	
Üw.-Mutter für	50	3	(36505R0104)	<b>4365051</b>	
Üw.-Mutter für	63	3	(36506R0104)	<b>4365061</b>	
Üw.-Mutter für	75	3	(36507R0104)	<b>4365071</b>	
Üw.-Mutter für	90	3	(36508R0104)	<b>4365081</b>	
Üw.-Mutter für	110	3	(36509R0104)	<b>4365091</b>	
Einlegeteil Klebe	16	5	(36500R0105)	<b>4365002</b>	
Einlegeteil Klebe	20	5	(36501R0105)	<b>4365012</b>	
Einlegeteil Klebe	25	5	(36502R0105)	<b>4365022</b>	
Einlegeteil Klebe	32	5	(36503R0105)	<b>4365032</b>	
Einlegeteil Klebe	40	5	(36504R0105)	<b>4365042</b>	
Einlegeteil Klebe	50	5	(36505R0105)	<b>4365052</b>	
Einlegeteil Klebe	63	5	(36506R0105)	<b>4365062</b>	
Einlegeteil Klebe	75	5	(36507R0105)	<b>4365072</b>	
Einlegeteil Klebe	90	5	(36508R0105)	<b>4365082</b>	
Einlegeteil Klebe	110	5	(36509R0105)	<b>4365092</b>	
0-Ring Einlegeteil	16/20	10	(723R0202035)	<b>041003</b>	
0-Ring Einlegeteil	25	10	(723R0282035)	<b>041013</b>	
0-Ring Einlegeteil	32	10	(723R0329035)	<b>041023</b>	
0-Ring Einlegeteil	40	10	(723R0407053)	<b>041033</b>	
0-Ring Einlegeteil	50	10	(723R0470053)	<b>041043</b>	
0-Ring Einlegeteil	63	10	(723R0597053)	<b>041053</b>	
0-Ring Einlegeteil	75	10	(723R0756053)	<b>041063</b>	
0-Ring Einlegeteil	90	10	(723R0914053)	<b>041073</b>	
0-Ring Einlegeteil	110	10	(723R1092057)	<b>041083</b>	
0-Ring Set	16/20	6-10	(36501R0135)	<b>4365006</b>	
0-Ring Set	25	6-10	(36502R0135)	<b>4365016</b>	
0-Ring Set	32	6-10	(36503R0135)	<b>4365036</b>	
0-Ring Set	40	6-10	(36504R0135)	<b>4365046</b>	
0-Ring Set	50	6-10	(36505R0135)	<b>4415446</b>	
0-Ring Set	63	6-10	(36506R0135)	<b>4415447</b>	
0-Ring Set	75	6-10	(36507R0135)	<b>4365076</b>	
0-Ring Set	90	6-10	(36508R0135)	<b>4365086</b>	
0-Ring Set	110	6-10	(36509R0135)	<b>4365096</b>	
Zapfen + 0-Ringe	16/20	1+7	(36501R0121)	<b>4365015</b>	
Zapfen + 0-Ringe	25	1+7	(36502R0121)	<b>4365025</b>	
Zapfen + 0-Ringe	32	1+7	(36503R0121)	<b>4365035</b>	
Zapfen + 0-Ringe	40	1+7	(36504R0121)	<b>4365045</b>	
Zapfen + 0-Ringe	50	1+7	(36505R0121)	<b>4365055</b>	
Zapfen + 0-Ringe	63	1+7	(36506R0121)	<b>4365065</b>	
Zapfen + 0-Ringe	75	1+7	(36507R0121)	<b>4365075</b>	
Zapfen + 0-Ringe	90	1+7	(36508R0121)	<b>4365085</b>	
Zapfen + 0-Ringe	110	1+7	(22797R0121)	<b>4365095</b>	

**ERSATZTEILE SCHWIMMBADKUGELHÄHNE PN 12 TYP EURO CEPEX**

Bezeichnung	DA	TL	Ref.-Nr.	Art.-Nr.	Preis
Üw.-Mutter für	50	3	(41941R0104)	<b>4415441</b>	
Üw.-Mutter für	63	3	(41545R0104)	<b>4415451</b>	
Einlegeteil Klebe	50	5	(36515R0105)	<b>4415442</b>	
Einlegeteil Klebe	63	5	(36516R0105)	<b>4415452</b>	
0-Ring Einlegeteil	50	9	(723R0470053)	<b>041043</b>	
0-Ring Einlegeteil	63	9	(723R0597053)	<b>041053</b>	
0-Ring Set	50	6-10	(36505R0135)	<b>4415446</b>	
0-Ring Set	63	6-10	(36506R0135)	<b>4415447</b>	

**ERSATZTEILE SCHWIMMBADKUGELHÄHNE PN 16/10 TYP STANDARD CEPEX**

**Gruppe A**  
exkl. MWSt.

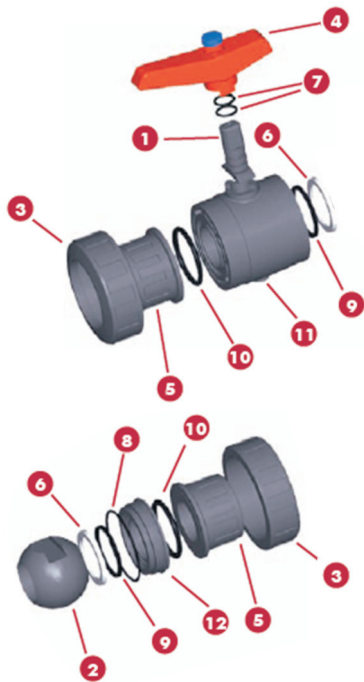

PN16/10

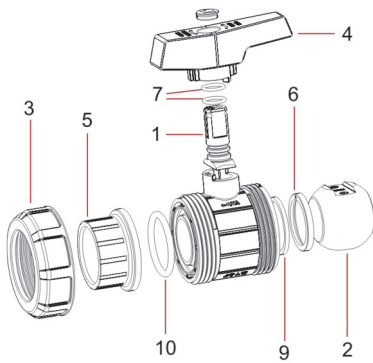

PN10

Bezeichnung	DA	TL	Ref.-Nr.	Art.-Nr.	Preis
Üw.-Mutter für	16/20	3	(02453R0104)	<b>041001</b>	
Üw.-Mutter für	25	3	(02454R0104)	<b>041011</b>	
Üw.-Mutter für	32	3	(02455R0104)	<b>041021</b>	
Üw.-Mutter für	40	3	(02456R0104)	<b>041031</b>	
Üw.-Mutter für	50	3	(02457R0104)	<b>041041</b>	
Üw.-Mutter für	63	3	(02458R0104)	<b>041051</b>	
Üw.-Mutter für	75	3	(02459R0104)	<b>041061</b>	
Üw.-Mutter für	90	3	(02460R0104)	<b>041071</b>	
Üw.-Mutter für	110	3	(22797R0104)	<b>041081</b>	
Einlegeteil Klebe	16	5	(05352R0105)	<b>040992</b>	
Einlegeteil Klebe	20	5	(02453R0105)	<b>041002</b>	
Einlegeteil Klebe	25	5	(02454R0105)	<b>041012</b>	
Einlegeteil Klebe	32	5	(02455R0105)	<b>041022</b>	
Einlegeteil Klebe	40	5	(02456R0105)	<b>041032</b>	
Einlegeteil Klebe	50	5	(02457R0105)	<b>041342</b>	
Einlegeteil Klebe	63	5	(02458R0105)	<b>041052</b>	
Einlegeteil Klebe	75	5	(02459R0105)	<b>041062</b>	
Einlegeteil Klebe	90	5	(02460R0105)	<b>041072</b>	
Einlegeteil Klebe	110	5	(22797R0105)	<b>041082</b>	
0-Ring Einlegeteil	16/20	10	(723R0202035)	<b>041003</b>	
0-Ring Einlegeteil	25	10	(723R0282035)	<b>041013</b>	
0-Ring Einlegeteil	32	10	(723R0329035)	<b>041023</b>	
0-Ring Einlegeteil	40	10	(723R0407053)	<b>041033</b>	
0-Ring Einlegeteil	50	10	(723R0470053)	<b>041043</b>	
0-Ring Einlegeteil	63	10	(723R0597053)	<b>041053</b>	
0-Ring Einlegeteil	75	10	(723R0756053)	<b>041063</b>	
0-Ring Einlegeteil	90	10	(723R0914053)	<b>041073</b>	
0-Ring Einlegeteil	110	10	(723R1092057)	<b>041083</b>	
0-Ring Set	16/20	7-10	(02453R0129)	<b>041008</b>	
0-Ring Set	25	7-10	(02454R0129)	<b>041018</b>	
0-Ring Set	32	7-10	(02455R0129)	<b>041028</b>	
0-Ring Set	40	7-10	(02456R0129)	<b>041038</b>	
0-Ring Set	50	7-10	(02457R0129)	<b>041048</b>	
0-Ring Set	63	7-10	(02458R0129)	<b>041058</b>	
0-Ring Set	75	7-10	(02459R0129)	<b>041068</b>	
0-Ring Set	90	7-10	(02460R0129)	<b>041078</b>	
0-Ring Set	110	7-10	(22797R0129)	<b>041088</b>	
Zapfen + 0-Ringe	16/20	1+7	(02453R0121)	<b>041000</b>	
Zapfen + 0-Ringe	25	1+7	(02454R0121)	<b>041010</b>	
Zapfen + 0-Ringe	32	1+7	(02455R0121)	<b>041020</b>	
Zapfen + 0-Ringe	40	1+7	(02456R0121)	<b>041030</b>	
Zapfen + 0-Ringe	50	1+7	(02457R0121)	<b>041040</b>	
Zapfen + 0-Ringe	63	1+7	(02458R0121)	<b>041050</b>	
Zapfen + 0-Ringe	75	1+7	(02459R0121)	<b>041060</b>	
Zapfen + 0-Ringe	90	1+7	(02460R0121)	<b>041070</b>	
Zapfen + 0-Ringe	110	1+7	(22797R0121)	<b>4365095</b>	

**ERSATZTEILE SCHWIMMBADKUGELHÄHNE PN 10 TYP STANDARD CEPEX**

Bezeichnung	DA	TL	Ref.-Nr.	Art.-Nr.	Preis
Üw.-Mutter für	50	3	(02502R0104)	<b>041341</b>	
Üw.-Mutter für	63	3	(02503R0104)	<b>041351</b>	
Einlegeteil Klebe	50	5	(02457R0105)	<b>041342</b>	
Einlegeteil Klebe	63	5	(02503R0105)	<b>041352</b>	
0-Ring Einlegeteil	50	10	(723R0470053)	<b>041043</b>	
0-Ring Einlegeteil	63	10	(723R0597053)	<b>041053</b>	
0-Ring Set 4-teilig	50	7-10	(02502R0129)	<b>041046</b>	
0-Ring Set 4-teilig	63	7-10	(02458R0129)	<b>041058</b>	

### 3-WEGE-SCHWIMMBADKUGELHÄHNE PVC-PN 16 / 10 CEPEX



Klebeanschluss-  
Dichtung HDPE, O-Ring EPDM, Temperaturbeständig bis 60°



#### TYP PN 10

DN	VE	Art.-Nr.	DA	Preis
40	1	04139	50	
40	1	04138	50/63	
40	1	40599218	manuell inkl. 3 Tüllen NW38	

### PVC-Sichtgläser- CEPEX

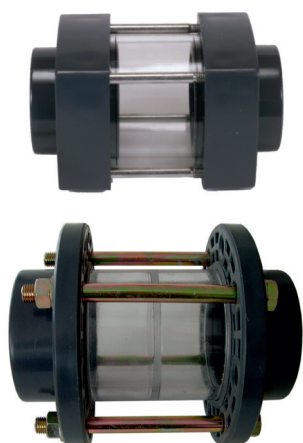

DN	Art.-Nr.	VE	DA	Preis
40	04165	1	50	
50	04166	1	63	
63	04167	1	75	
75	04168	1	90	
90	04169	1	110	
110	04170	1	140	
140	04171	1	160	
200	041711	1	225	

### PVC-ABLASSVENTILE PN 10 PRAHER - CEPEX

Material: PVC  
max. Betriebsdruck: PN 10



Bezeichnung	Art.Nr.	Gewinde	Preis
Ablassventil schwarz	080671	3/4" AG x 3/4" AG	
Ablassventil schwarz	080681	3/4" AG x NW 16 (Gardenaanschluss)	
Ablassventil	04116	3/4" IG / 3/4" AG	
Üw.-Mutter und Tülle	04118	3/4" IG x NW 19	
Ablassventil	04468	1/4"AG x NW 10	





## PVC-ZUGSCHIEBER - VALTERRA



PVC-Zugschieber versehen mit einer Spindel aus Edelstahl mit 3-facher Dichtung im oberen Teil (3 x O-Ring). Anwendungen: Teiche, Schwimmbäder, Whirlpools, Tanks, Gartenbau. Die Zugschieber sind mit Sanlopren Abdichtungen (100 % chemisch beständig) versehen, die sowohl für Vakuum als auch für Druck geeignet sind. Der Schieber ist aus Kunststoff, außer der 110/160/200 mm, dieser ist aus Edelstahl. Ideal für Niederdruck-Anlagen. Auf Anfrage auch in inch-Klebeverbindungenmassen lieferbar.

2 x Klebemuffe



Typ	A	B	C	D	E	F
50mm	168	222	72.6	50.3	98	98
63mm	191	260	85.4	63.3	111	105
75/90mm	238	324	111	75.3	130	133
90mm	238	324	111	90.3	130	133
110mm	330	454	169	110.4	181	130
160mm	572	800	279.4	160.7	343	279
200mm	572	797	279.4	200.7	327	276

B = Höhe bei komplett geöffneter Schraube

DA	Art.-Nr.	VE	Arbeitsdruck bei 20°C	Preis
50	SBSB120	26	max. 3,5 bar	
63	SBSB121	16	max. 2,8 bar	
75	SBSB119	12	max. 1,4 bar	
90	SBSB122	12	max. 1,4 bar	
90 (mit Edelstahlschieber)	SBSB118	12	max. 1,4 bar	
110 (mit Edelstahlschieber)	SBSB123	6	max. 1,0 bar	
160 (mit Edelstahlschieber)	SBSB124	1	max. 1,0 bar	
200 (mit Edelstahlschieber)	SBSB125	1	max. 1,0 bar	

## PVC-ABSPERRSCHIEBER ASTRAL CEPEX



Art.-Nr.	Bezeichnung	Preis
428940	<b>Absperrschieber Außengewinde 6/4" / Tülle NW 38,</b> VE = 10 (28940) grau	
428941	<b>Absperrschieber Klebemuffe DA 50 / Tülle NW 38,</b> VE = 10 (28935) grau	
428942	<b>Absperrschieber Klebemuffe / Klebemuffe DA 50,</b> VE = 10 (28590) grau	
428943	<b>Absperrschieber Innengewinde 6/4" / Außengewinde 6/4",</b> VE = 10 (28942) grau	
428944	<b>Absperrschieber Innengewinde 6/4" / Tülle NW 38,</b> VE = 10 (28947) grau	

## RÜCKSCHLAGVENTILE KLEBE CEPEX

Material: PVC 16 bar Dichtung PVC-Klebeanschluss EPDM Standardausführung - Federbelastet

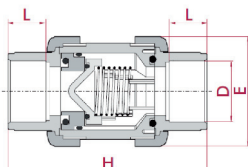

D	Art.-Nr.	DN	PN	H	L	E	VE	Preis
20	04151	15	16	84	16	52	48	
25	04152	20	16	108	19	62	24	
32	04153	25	16	119	22	70	20	
40	04154	32	16	142	26	84	12	
50	04155	40	16	162	31	94	24	
63	04156	50	16	192	38	117	12	
75	04157	65	16	232	44	148	4	
90	04158	80	16	269	51	179	2	
110	04159	100	16	279	61	229	2	



## PVC-SCHRÄGSITZ RÜCKSCHLAGVENTILE

€ **Gruppe B**  
exkl. MWSt.

Material: PVC-U, ABS 10 bar Dichtung PVC-Klebeanschluss EPDM/FPM

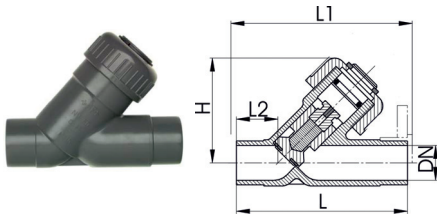

D	Art.-Nr.	DN	PN	H	L	L <sub>1</sub>	L <sub>2</sub>	Preis
20	16227	15	10	65	124	130	28	
25	162271	20	10	75	144	150	37	
32	162272	25	10	90	154	160	37	
40	162273	32	10	102	174	180	44	
50	162274	40	10	123	194	200	48	
63	162275	50	10	144	224	230	60	

€ **Gruppe A**  
exkl. MWSt.

## PVC-RÜCKSCHLAGKLAPPEN - CEPEX - nicht federbelastet mit Flanschanschluss im Set

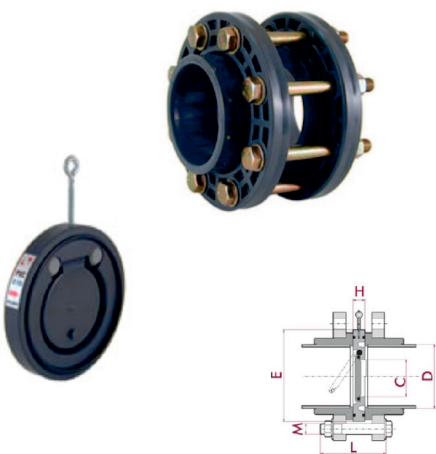

D	Art.-Nr.	DN	PN	C	H	E	VE	Preis
63	437073	50	10	32	20	109	2	
75	423312	65	10	40	20	129	2	
90	423313	80	10	52	20	144	3	
110	423314	100	10	70	23	164	2	
125	423315	110	10	83	25	170	2	
140	423316	125	10	92	24	195	2	
160	423317	150	6	112	26	220	1	
200	423318	175	6	139	28	247	1	
225	423319	200	6	150	35	275	1	
250	437074	250	6	162	40	328	1	
315	437075	300	6	226	45	380	1	

## PVC-RÜCKSCHLAGKLAPPEN - CEPEX - federbelastet

### Type PVC EPDM S 4.70

Waagrechter Einbau mit **Edelstahlfeder**

O-Ring EPDM oder FPM

für pulsierende Strömungsverhältnisse



D	Art.-Nr.	Preis
50	08036	
63	08037	
75	08038	
90	08039	
110	08040	
140	08041	
160	08042	

Senkrechter Einbau Standard ohne Feder O-Ring EPDM oder FPM

D	Art.-Nr.	PN	A	B	C	VE	Preis
63	437055	10	109	20	32	15	
75	408984	10	129	20	40	10	
90	408985	10	144	20	52	8	
110	408986	10	164	23	70	5	
140	408987	10	195	24	92	10	
160	408988	6	220	26	112	5	
225	408989	6	275	35	150	3	

## PP-GF-ABSPERRKLAPPEN CEPEX INDUSTRIEAUSFÜHRUNG



PP-GF Gehäuse  
Blauer Farbpunkt  
O-Ringe EPDM nahrungsmittelverträglich  
Achse Edelstahl (AISI630)  
PVC-U Scheiben  
Handhebel in PP



VE	Art.-Nr.	DA	PN	Preis
2	432620	63-75	10	
2	432621	90	10	
2	432622	110	10	
2	432623	125-140	10	
2	432624	160	10	
1	432625	200-225	10	

Auf Anfrage mit Viton-Dichtung.

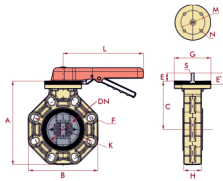

D	DN	A	B	C	E	F	G	H	K	L	M	N	E'	S	holes
63-75	65	201	156	50	40	13	112	48	125-145	220	70	4	35	10	4
90	80	232	190	56	40	19	112	52	156-170	245	70	4	35	12	8
110	100	255	212	58	40	19	118	58	186-192	245	70	4	35	14	8
125-140	125	284	238	64	40	22	112	66	190-215	320	70	4	35	20	8
160	150	314	265	80	40	24	112	72	240	320	70	4	35	20	8
200-225	200	378	320	917	50	23	136	73	270-298	391	102	11	47	24	8

PP-GF Gehäuse  
O-Ringe EPDM nahrungsmittelverträglich  
Achse Edelstahl (AISI630)  
PVC-U Scheiben



VE	Art.-Nr.	DA	PN	Preis
1	434466	63-75	10	
1	434467	90	10	
1	434468	110	10	
1	434469	125-140	10	
1	434470	160	10	
1	434471	200-225	10	
1	434472	250-280	6	
1	432738	315	6	

Auf Anfrage mit Viton-Dichtung.

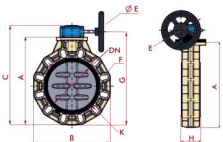
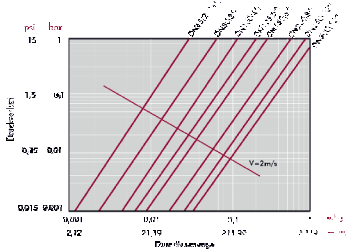

D	DN	A	B	E	C	F	G	H	K	holes
63-75	65	198	156	140	245	18	218	48	125-145	4
90	80	221	190	140	274	19	249	52	150-170	8
110	100	244	212	140	299	19	272	58	180-192	8
125-140	125	273	238	140	328	22	301	66	190-215	8
160	150	303	265	140	358	24	331	72	240	8
200-225	200	366	320	210	421	23	394	73	270-298	8
250-280	250	458	420	310	525	29	498	114	330-369	12
315	300	545	477	310	619	29	578	114	390-432	12

## PVC-ABSPERRKLAPPEN CEPEX STANDARDAUSFÜHRUNG

Handbetätigt / Normalausführung  
Material: EPDM  
ohne Flansch und  
Bundbuche



DN	Art.-Nr.	DA	PN	Preis
65	04120	75	10	
80	04121	90	10	
100	04122	110	10	
125	04123	140	10	
150	04124	160	10	
200	04125	225	10	
225	415846	250	6	

## FLANSCHSETZ FÜR ABSPERRKLAPPE

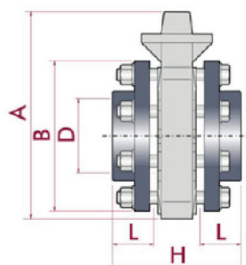

DN	Art.-Nr.	DA	PN	Preis
50	409119	63	10	
65	409120	75	10	
80	409121	90	10	
100	409122	110	10	
110	409123	125	10	
125	409124	140	10	
150	409125	160	10	
175	409126	200	10	
200	409127	225	10	
225	416060	250	10	

## PP-MOTORKLAPPEN PNEUMATISCH CEPEX



Absperrrklappe mit pneumatischem Stellantrieb, doppelt wirkend, Dichtung EPDM, Achse aus Edelstahl, komplett mit Magnetventil 230 V und Stellungsanzeige



VE	Art.-Nr.	DA	Preis
1	402664	75	
1	402665	90	
1	402666	110	
1	402668	140	
1	402669	160	
1	402670	225	

## PP-MOTORKLAPPEN ELEKTRISCH CEPEX

Absperrrklappe mit elektrischem Stellantrieb 80 - 240 V Gleich- oder Wechselstrom  
Dichtung EPDM, Achse aus Edelstahl

Mit Sicherheitsblock - schliesst bei Stromausfall automatisch!



VE	Art.-Nr.	DA	Preis
1	405382	75	
1	405383	90	
1	405384	110	
1	405386	140	
1	405387	160	
1	405388	225	

## PVC-2/3-WEGE-MOTORKUGELHÄHNE 230 V CEPEX

Typ AS, 230 Volt, PVC-Klebeanschluss  
EPDM Teflondichtung

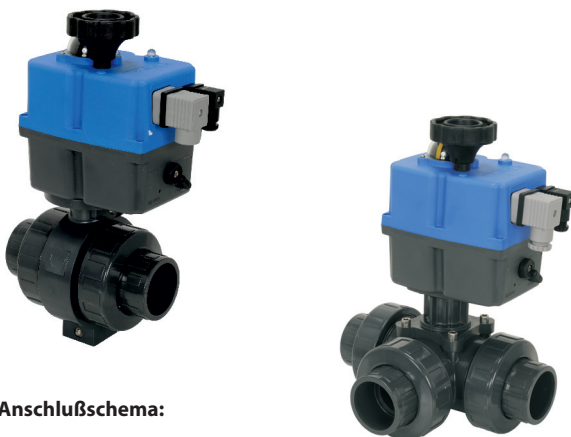

Anschlussschema:

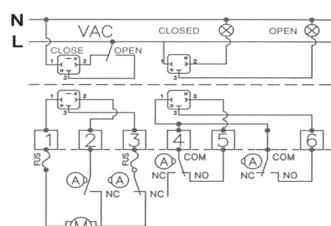

DN	VE	Art.-Nr.	DA	Preis
40	1	04266	50 2-Wege	
50	1	042660	63 2-Wege	
40	1	427228	50 3-Wege mit Sicherheitsblock	
40	1	405370	50 2-Wege mit Sicherheitsblock	
50	1	405371	63 2-Wege mit Sicherheitsblock	
40	1	042663	50 3-Wege	

Ventildurchm.	Elektrisches Stellglied	Maß "D"
20	U-0	64
25	U-0	64
32	U-0	74
40	U-0	74
50	R-0	88
63	R-0	88
75	R-1	123
90	R-1	123

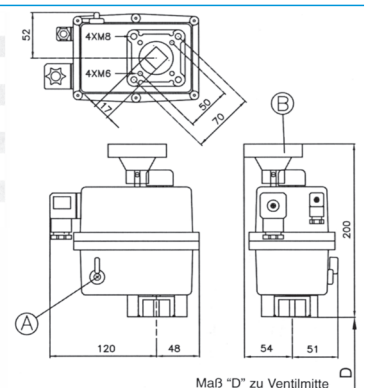

Maß "D" zu Ventilmitte



## PVC-FITTINGE - CEPEX

**Cepex – Experten in der Übertragung der Flüssigkeit** - In mehr als 25-jähriger Marktpräsenz konnte Cepex stets höchste Kundenzufriedenheit erzielen und sich dank Ihrer Unterstützung und Treue als einer der europäischen Hauptlieferanten von Ventilen und Fittingen aus Plastik etablieren. Dies führte zum Aufbau eines eigenen weltweiten Vertriebsnetzes.

**Unternehmensphilosophie** - Cepex vereint alle Kräfte, um dem Markt effiziente Lösungen anzubieten und verfolgt dabei fünf Prinzipien mit dem Ziel, zuverlässige und konkurrenzfähige Produkte zu präsentieren: **Forschung** - Um sich vom derzeitigen Markt abzuheben, müssen die Unternehmen in der Lage sein, auf die sich schnell ändernden Nachfragen und Wünsche der Kunden zu reagieren. Deshalb setzt Cepex stetig auf Innovation und Forschung, unterstützt von einer Expertengruppe der I+D, die systematisch die verschiedenen Märkte analysieren, um Produkte und praktikable Lösungen für den Bedarf anzubieten. **Technologie** - Der Produktionsprozess, angefangen von der Konzeption des Produktes bis hin zur seiner Auslieferung an den Kunden, wird mit Hilfe der fortgeschrittensten Technologie und ständiger Weiterentwicklung derselben dazu genutzt, um ein Maximum an Qualität und ein Minimum an Fehlern zu garantieren. Dies erreicht Cepex Holding durch:

- **Eigene Werkzeugfabrik**
- **Spritzgussmaschinen, Robotern und Spitzentechnologien**
- **Einem hochentwickeltem Logistikzentrum**

**Qualität** - Die Produktionsprozesse werden von einem Qualitätsmanagement-System begleitet, sie sind durch die Zertifizierung ISO 9001 dokumentiert. Die Produkte sind härtesten Kontrollen unterworfen, was eine 100%-Überprüfung eines jeden Ventilmodells bedeutet. Cepex erhielt daher zahlreiche Auszeichnungen, die weltweit anerkannte Prüfinstitute verliehen. **Service** - Eine der wesentlichen Aufgaben der Mitarbeiter aller Tochtergesellschaften und alle zur Gruppe gehörenden Teams liegen in der optimalen Betreuung ihrer Kunden. Ihm gegenüber steht eine erfahrene Mannschaft von Technikern und Kaufleuten, die Fragen zum Produkt und dessen Funktionen zuverlässig beantworten können. **Umweltpolitik** - Cepex ist eine Firma, die verantwortlich mit der Umwelt umgeht. Damit alle eine saubere Umwelt genießen können, wird die Wahl der Produktionsmittel sorgfältig abgewogen. Um dieser Verpflichtung gerecht zu werden, ist in unseren Produktionsstätten ein auf der ISO 14001-Norm basierendes Regelwerk installiert, das alle erforderlichen Aktivitäten und Dienste vorschreibt.

### Prüfzeichen und Zertifikate:



## PVC-FITTINGE - PN 10 - CEPEX

**Gruppe A**  
exkl. MWSt.

Farbe dunkelgrau ca. RAL 7024

Winkel 90° Klebemuffe / Klebemuffe



D	Art.-Nr.	DN	PN	VE	Preis
50	419206	40	10	70	
63	419207	50	10	36	

Winkel 45° Klebemuffe / Klebemuffe



50	419210	40	10	40	
63	419211	50	10	48	

T-Stücke egal 3 x Klebemuffe



50	419208	40	10	48	
63	419209	50	10	24	

Muffen



50	419212	40	10	60	
63	419213	50	10	35	

Übergangsnippel



50 x 1 1/2" AG	419214	40	10	48	
63 x 2" AG	419215	50	10	24	

Verschraubungen Klebemuffe / Klebemuffe



50	402331	40	10	30	
63	402332	50	10	12	



PVC-FITTINGE - CEPEX



Farbe dunkelgrau ca. RAL 7024

Winkel 90°

Klebhemme / Klebhemme

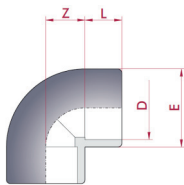

D	Art.-Nr.	DN	PN	L	Z	E	VE	Preis
16	411655	10	16	14	10	25	20	
20	401712	15	16	16	11	27	20	
25	401713	20	16	19	14	33	10	
32	401714	25	16	22	17	41	10	
40	401715	32	16	26	21	50	55	
50	401716	40	16	31	26	61	60	
63	401717	50	16	38	33	76	36	
75	401718	65	16	44	39	90	21	
90	401719	80	16	51	46	108	12	
110	401720	100	16	61	56	131	14	
125	401721	110	16	69	64	148	10	
140	401722	125	16	76	71	164	5	
160	401723	150	10	86	81	180	4	
200	401724	175	10	106	101	225	3	
225	401725	200	10	119	114	252	2	
250	401726	225	10	131	126	284	2	
315	401727	300	10	164	159	352	1	
400	434807	353	5	206	202	439	3	

Übergangswinkelwinkel 90°

Klebhemme / IG

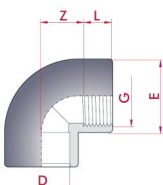

D x G	Art.-Nr.	DN	PN	L	Z	E	VE	Preis
20 x 1/2"	401728	15	10	14	11	28	10	
25 x 3/4"	401729	20	10	16	14	34	10	
32 x 1"	401730	25	10	19	17	43	10	
40 x 1 1/4"	401731	32	10	20	21	54	10	
50 x 1 1/2"	401732	40	10	20	26	63	28	
63 x 2"	401733	50	10	24	33	78	16	
75 x 2 1/2"	422596	65	10	44	40	89	9	
90 x 3"	422597	80	10	51	48	106	6	
110 x 4"	422598	100	10	61	58	129	3	

Übergangswinkelwinkel 90° verstärkt

Klebhemme / IG

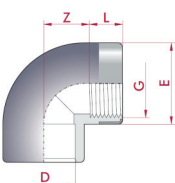

D x G	Art.-Nr.	DN	PN	L	Z	E	VE	Preis
20 x 1/2"	401740	15	16	14	11	28	10	
25 x 3/4"	401741	20	16	16	14	34	10	
32 x 1"	401742	25	16	19	17	43	10	
40 x 1 1/4"	401743	32	16	20	21	54	10	
50 x 1 1/2"	401744	40	16	20	26	63	28	
63 x 2"	401745	50	10	24	33	78	16	

Winkel 90°

IG / IG

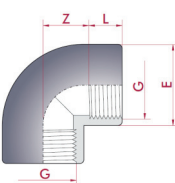

D	Art.-Nr.	DN	PN	L	Z	E	VE	Preis
1/2"	401734	15	10	14	11	28	10	
3/4"	401735	20	10	16	14	34	10	
1"	401736	25	10	19	17	43	10	
1 1/4"	401737	32	10	20	21	54	10	
1 1/2"	401738	40	10	20	26	63	28	
2"	401739	50	10	24	33	78	16	
2 1/2"	422587	65	10	30	54	89	9	
3"	422588	80	10	33	66	106	6	
4"	422589	100	10	39	80	129	3	



PVC-FITTINGE - CEPEX



Farbe dunkelgrau ca. RAL 7024

Reduzierwinkel 90°

Klebhemme / Klebhemme

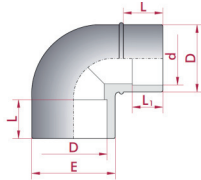

D x D - d	Art.-Nr.	DN	PN	L	L <sub>1</sub>	E	VE	Preis
50 x 50 - 40	402237	40	16	31	26	61	70	
63 x 63 - 50	402238	50	16	38	31	76	32	

Winkel 90°

Klebhemme / AG

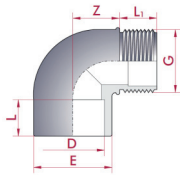

D x G	Art.-Nr.	DN	PN	L <sub>1</sub>	L	E	Z	VE	Preis
50 x 1½"	402239	40	10	21	31	61	38	80	
63 x 2"	402240	50	10	25	38	76	47	42	

Winkel 45°

Klebhemme / Klebhemme

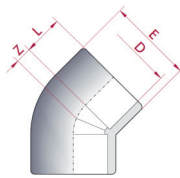

D	Art.-Nr.	DN	PN	L	Z	E	VE	Preis
16	416307	10	16	14	5	22	20	
20	401746	15	16	16	5	28	20	
25	401747	20	16	19	6	35	10	
32	401748	25	16	22	8	43	10	
40	401749	32	16	26	10	52	60	
50	401750	40	16	31	12	61	80	
63	401751	50	16	38	14	76	45	
75	401752	65	16	44	17	93	25	
90	401753	80	16	51	20	109	15	
110	401754	100	16	61	24	133	16	
125	401755	110	16	69	27	148	12	
140	401756	125	16	76	30	164	8	
160	401757	150	10	86	34	180	5	
200	401758	175	10	106	43	225	4	
225	401759	200	10	119	48	252	2	
250	401760	225	10	131	53	284	2	
315	401761	300	10	164	67	352	1	
400	434808	353	5	206	83	439	4	

Übergangswinkelwinkel 45° verstärkt

Klebhemme / IG

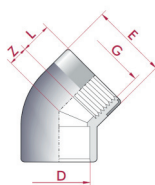

D x G	Art.-Nr.	DN	PN	L	Z	E	VE	Preis
20 x ½"	401774	15	16	14	5	28	10	
25 x ¾"	401775	20	16	16	6	34	10	
32 x 1"	401776	25	16	19	8	43	10	
40 x 1¼"	401777	32	16	20	10	54	10	
50 x 1½"	401778	40	16	20	12	63	35	
63 x 2"	401779	50	16	24	14	78	18	

Reduzierwinkel 45°

Klebhemme / Klebhemme

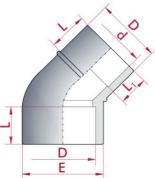

D x D - d	Art.-Nr.	DN	PN	L	L <sub>1</sub>	E	VE	Preis
50 x 50 - 40	402241	32	16	31	26	61	90	
63 x 63 - 50	402242	40	16	38	31	76	50	



**PVC-FITTINGE - CEPEX**



Farbe dunkelgrau ca. RAL 7024

**Bogen 90°**

Klebhemme / Klebhemme

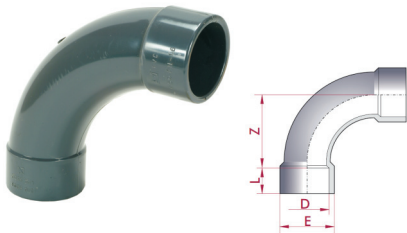

D	Art.-Nr.	DN	PN	L	Z	E	VE	Preis
20	401967	15	16	16	40	27	10	
25	401968	20	16	19	50	33	10	
32	401969	25	16	22	64	41	24	
40	401970	32	16	26	80	50	25	
50	401971	40	16	31	100	61	30	
63	401972	50	16	38	126	76	15	
75	401973	65	16	44	150	90	8	
90	405331	80	16	51	180	113	4	
110	405332	100	16	61	134	132	4	
125	405333	110	10	69	186	150	5	
140	405334	125	10	76	166	164	4	
160	405335	150	10	86	194	186	4	
200	405336	175	4	106	284	223	1	
225	405337	200	4	119	296	251	1	
250	405338	225	4	131	334	275	1	
315	405339	300	4	165	520	348	4	
400	405340	353	4	206	614	432	2	

**Muffe egal**

3Klebhemme / Klebhemme

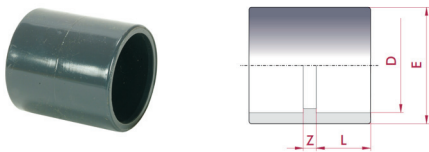

D	Art.-Nr.	DN	PN	L	Z	E	VE	Preis
16	416309	10	16	14	3	22	20	
20	401872	15	16	16	3	27	20	
25	401873	20	16	19	3	33	20	
32	401874	25	16	22	3	41	20	
40	401875	32	16	26	3	50	10	
50	401876	40	16	31	3	61	56	
63	401877	50	16	38	3	75	34	
75	401878	65	16	44	4	90	14	
90	401879	80	16	51	5	108	18	
110	401880	100	16	61	6	129	12	
125	401881	110	16	69	7	148	16	
140	401882	125	16	76	9	164	12	
160	401883	150	10	86	9	180	6	
200	401884	175	10	106	10	225	3	
225	401885	200	10	119	10	252	4	
250	401886	225	10	131	12	280	2	
315	401887	300	10	164	12	352	1	
400	405329	375	6	206	12	432	1	





## PVC-FITTINGE - CEPEX



Farbe dunkelgrau ca. RAL 7024

### Verschraubung 3-teilig

Klebhemme / Klebhemme, EPDM O-Ring

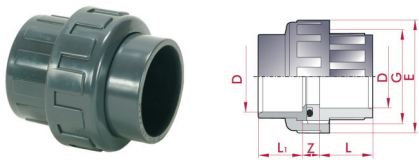

D	Art.-Nr.	DN	PN	L	L <sub>1</sub>	Z	G	E	O	VE	Preis
16	420157	12	16	14	14	13	3/4"	34	15,5 x 2,6	10	
20	402327	15	16	16	16	13	1"	41	20,2 x 3,5	10	
25	402328	20	16	19	19	13	1 1/4"	52	28,2 x 3,5	10	
32	402329	25	16	22	22	13	1 1/2"	60	32,9 x 3,5	30	
40	402330	32	16	26	26	15	2"	74	40,6 x 5,3	40	
50	402331	40	16	31	31	17	2 1/4"	80	47,0 x 5,3	30	
63	402332	50	16	38	38	21	2 3/4"	99	59,7 x 5,3	12	
75	402333	65	10	44	44	21	3 1/2"	120	75,6 x 5,3	16	
90	402334	80	10	51	51	24	4"	138	91,4 x 5,3	12	
110	402335	100	10	61	61	26	5 1/2"	179	110,5 x 5,3	5	

### Übergangs-Verschraubung 3-teilig

Klebhemme / IG, EPDM O-Ring

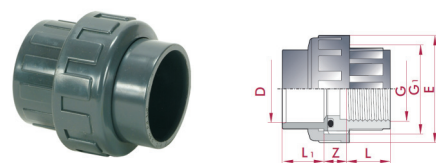

D x G	Art.-Nr.	DN	PN	L	L <sub>1</sub>	Z	G <sub>1</sub>	E	O	VE	Preis
16 x 3/8"	420158	12	16	14	14	13	3/4"	34	15,5 x 2,6	10	
20 x 1/2"	402336	15	16	16	16	13	1"	41	20,2 x 3,5	10	
25 x 3/4"	402337	20	16	19	19	13	1 1/4"	52	28,2 x 3,5	10	
32 x 1"	402338	25	16	22	22	13	1 1/2"	60	32,9 x 3,5	30	
40 x 1 1/4"	402339	32	16	26	26	15	2"	74	40,6 x 5,3	40	
50 x 1 1/2"	402340	40	16	31	31	17	2 1/4"	80	47,0 x 5,3	30	
63 x 2"	402341	50	16	38	38	21	2 3/4"	99	59,7 x 5,3	12	
75 x 2 1/2"	402342	65	10	44	44	21	3 1/2"	120	75,6 x 5,3	16	
90 x 3"	402343	80	10	51	51	24	4"	138	91,4 x 5,3	12	
110 x 4"	402344	100	10	61	61	26	5 1/2"	179	110,5 x 5,3	5	

### Verschraubung 3-teilig

Klebhemme / Klebestutzen, EPDM O-Ring

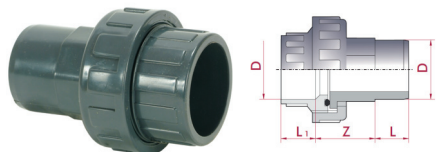

D	Art.-Nr.	DN	PN	L	L <sub>1</sub>	Z	VE	Preis
50	402351	40	16	31	31	48	20	
63	402352	50	16	38	38	62	12	

### Übergangs-Verschraubung 3-teilig

Klebhemme / AG, EPDM O-Ring ohne O-Ring am Gewinde

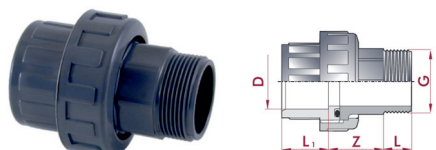

D x G	Art.-Nr.	DN	PN	L <sub>1</sub>	L	Z	VE	Preis
16 x 3/8"	420160	12	16	14	12	29	10	
20 x 1/2"	402353	15	16	16	15	33	10	
25 x 3/4"	402354	20	16	19	16	35	10	
32 x 1"	402355	25	16	22	19	40	30	
40 x 1 1/4"	402356	32	16	26	21	40	36	
50 x 1 1/2"	402357	40	16	31	21	48	30	
63 x 2"	402358	50	16	38	28	62	12	
75 x 2 1/2"	402359	65	10	44	30	70	16	
90 x 3"	402360	80	10	51	33	62	10	
110 x 4"	402361	100	10	61	40	70	4	

### Übergangs-Verschraubung 3-teilig

Klebhemme / AG, EPDM O-Ring mit O-Ring am Gewinde

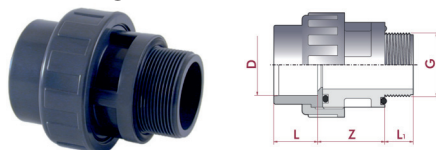

D x G	Art.-Nr.	DN	PN	L	L <sub>1</sub>	Z	VE	Preis
50 x 1 1/2"	407716	40	16	31	21	49	30	
50 x 2"	426638	40	16	31	28	46	12	
63 x 2"	407717	50	16	38	28	51	12	

### Anschlussstück orientierbar

max. Falschrichtung +/- 4°

Klebhemme / AG

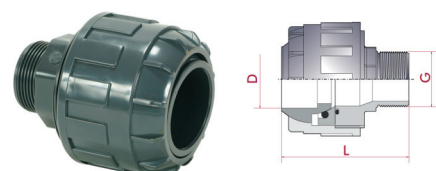

D x G	Art.-Nr.	DN	PN	L	VE	Preis
50 x 1 1/2"	418874	40	10	110	6	



PVC-FITTINGE - CEPEX



Farbe dunkelgrau ca. RAL 7024  
T-Stück 90°, 3 x Klebemuffe

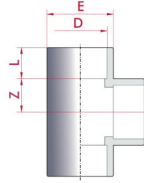

D	Art.-Nr.	DN	PN	L	Z	E	VE	Preis
16	416308	10	16	14	9	22	20	
20	401780	15	16	16	11	27	20	
25	401781	20	16	19	14	33	10	
32	401782	25	16	22	17	41	10	
40	401783	32	16	26	21	50	40	
50	401784	40	16	31	26	63	48	
63	401785	50	16	38	33	78	24	
75	401786	65	16	44	39	90	15	
90	401787	80	16	51	46	108	8	
110	401788	100	16	61	56	131	10	
125	401789	110	16	69	64	148	7	
140	401790	125	16	76	71	164	4	
160	401791	150	10	86	81	186	3	
200	401792	175	10	106	101	228	2	
225	401793	200	10	119	114	255	2	
250	401794	225	10	131	126	284	1	
315	401795	300	10	164	159	356	1	
400	405328	325	4	206	280	432	3	

Übergangs T-Stück 90° verstärkt  
Klebemuffe / IG, Edelstahl verstärkt

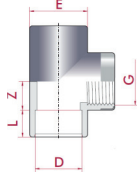

D x G	Art.-Nr.	DN	PN	L	Z	E	VE	Preis
20 x 1/2"	401808	15	16	14	11	28	10	
25 x 3/4"	401809	20	16	16	14	34	10	
32 x 1"	401810	25	16	19	17	43	10	
40 x 1 1/4"	401811	32	16	20	21	54	19	
50 x 1 1/2"	401812	40	16	20	26	63	21	
63 x 2"	401813	50	16	24	33	78	12	

T-Stück reduziert 90°, 3 x Klebemuffe

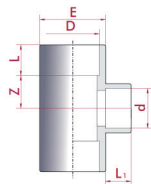

D x d	Art.-Nr.	DN	PN	L	L1	Z	E	VE	Preis
25 x 20	401814	20 - 15	16	19	16	14	33	10	
32 x 25	401815	25 - 20	16	22	19	17	41	10	
32 x 20	401816	25 - 15	16	22	16	17	41	10	
40 x 32	401817	32 - 25	16	26	22	21	50	48	
40 x 25	401818	32 - 20	16	26	19	21	50	48	
50 x 40	401820	40 - 32	16	31	26	26	61	48	
50 x 32	401821	40 - 25	16	31	22	26	61	48	
50 x 25	401822	40 - 20	16	31	19	26	61	54	
50 x 20	401823	40 - 15	16	31	16	26	61	56	
63 x 50	401824	50 - 40	16	38	31	33	76	27	
63 x 40	401825	50 - 32	16	38	26	33	76	28	
63 x 32	401826	50 - 25	16	38	22	33	76	30	
63 x 25	401827	50 - 20	16	38	19	33	76	30	
63 x 20	401828	50 - 15	16	38	16	33	76	30	
75 x 63	401829	65 - 50	16	44	38	39	90	16	
75 x 50	401830	65 - 40	16	44	31	39	90	18	
75 x 40	401831	65 - 32	16	44	26	39	90	18	
75 x 32	401832	65 - 25	16	44	22	39	90	18	
90 x 75	401833	80 - 65	16	51	44	46	108	9	
90 x 63	401834	80 - 50	16	51	38	46	108	9	
90 x 50	401835	80 - 40	16	51	31	46	108	9	
90 x 40	401836	80 - 32	16	51	26	46	108	9	
110 x 90	401837	100 - 80	16	61	51	56	131	11	
110 x 75	401838	100 - 65	16	61	44	56	131	12	
110 x 63	401839	100 - 50	16	61	38	56	131	12	
110 x 50	401840	100 - 40	16	61	31	56	131	12	
125 x 110	401841	110 - 100	16	69	61	64	149	7	
125 x 90	401842	110 - 80	16	69	51	64	149	8	
125 x 75	401843	110 - 65	16	69	44	64	149	8	
125 x 63	401844	110 - 50	16	69	38	64	149	8	
140 x 125	401845	125 - 110	16	76	69	71	162	5	
140 x 110	401846	125 - 100	16	76	61	71	162	6	
140 x 90	401847	125 - 80	16	76	51	71	162	6	
140 x 75	401848	125 - 65	16	76	44	71	162	6	
160 x 140	407688	150 - 125	10	86	76	81	186	3	
160 x 125	407689	150 - 110	10	86	69	81	186	3	
160 x 110	407690	150 - 100	10	86	61	81	186	3	
160 x 90	407691	150 - 80	10	86	51	81	186	3	



PVC-FITTINGE - CEPEX



Farbe dunkelgrau ca. RAL 7024

T-Stück 45°

3 x Klebemuffe

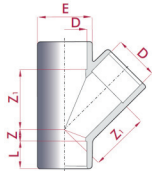

D x d	Art.-Nr.	DN	PN	L	Z	Z <sub>1</sub>	E	VE	Preis
20	422583	15	16	16	7	29	28	10	
25	422584	20	16	19	7	36	34	10	
32	422585	25	16	22	8	44	42	24	
40	422586	32	16	26	10	54	51	30	
50	420155	40	10	31	13	67	61	32	
63	420156	50	10	38	15	83	76	18	
75	432804	65	10	44	18	101	91	11	
90	432805	80	10	51	20	122	106	6	
110	432806	100	10	61	27	149	133	7	

Kreuz-Stück

4 x Klebemuffe

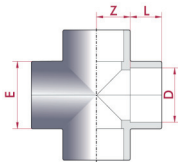

D	Art.-Nr.	DN	PN	L	Z	E	VE	Preis
20	420143	15	16	16	11	29	10	
25	420144	20	16	19	14	35	10	
32	420145	25	16	22	17	43	10	
40	420146	32	16	26	21	52	30	
50	402235	40	16	31	26	63	32	
63	402236	50	16	38	33	79	16	
75	427958	65	16	42	39	92	12	
90	422581	80	16	51	46	106	12	
110	422582	100	16	61	56	130	6	

Übergangsmuffe

Klebhemuffe /IG

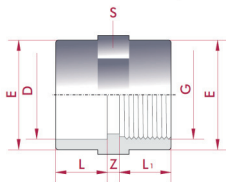

D x G	Art.-Nr.	DN	PN	L	L <sub>1</sub>	Z	E	S	VE	Preis
16 x 3/8"	401888	12	10	14	14	3	22	22	20	
20 x 1/2"	401889	15	10	16	14	3	28	27	20	
25 x 3/4"	401890	20	10	19	16	3	34	33	20	
32 x 1"	401891	25	10	22	19	3	43	41	20	
40 x 1 1/4"	401892	32	10	26	20	3	54	50	10	
50 x 1 1/2"	401893	40	10	31	20	3	63	61	56	
63 x 2"	401894	50	10	38	24	3	78	75	28	
75 x 2 1/2"	401895	65	10	44	44	4	90	90	14	
90 x 3"	401896	80	10	51	51	6	108	108	24	
110 x 4"	401897	90	10	61	61	6	135	135	10	

Übergangsmuffe, verstärkt

Klebhemuffe /IG, Edelstahl verstärkt

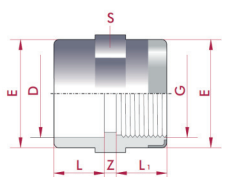

D x G	Art.-Nr.	DN	PN	L	L <sub>1</sub>	Z	E	S	VE	Preis
20 x 1/2"	401908	15	16	16	14	3	28	27	20	
25 x 3/4"	401909	20	16	19	16	3	34	33	10	
32 x 1"	401910	25	16	22	19	3	43	41	10	
40 x 1 1/4"	401911	32	16	26	20	3	54	50	10	
50 x 1 1/2"	401912	40	16	31	20	3	63	61	56	
63 x 2"	401913	50	16	38	24	3	78	75	28	



PVC-FITTINGE - CEPEX



Farbe dunkelgrau ca. RAL 7024

Reduktion kurz

Klebhemmung / Klebestutzen

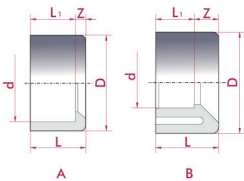
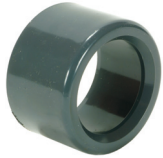

D x d	Art.-Nr.	DN	PN	L	L <sub>1</sub>	Z	Mod.	VE	Preis
20 x 16	401914	10	16	16	14	2	A	20	
25 x 20	401915	15	16	19	16	3	A	20	
32 x 25	401916	20	16	22	19	3	A	20	
32 x 20	401917	15	16	22	16	6	A	20	
40 x 32	401918	25	16	26	22	4	A	20	
40 x 25	401919	20	16	26	19	7	A	10	
40 x 20	401920	15	16	26	16	10	B	10	
50 x 40	401921	32	16	31	26	5	A	20	
50 x 32	401922	25	16	31	22	9	B	10	
50 x 25	401923	20	16	31	19	12	B	10	
50 x 20	401924	15	16	31	16	15	B	10	
63 x 50	401925	40	16	38	31	7	A	48	
63 x 40	401926	32	16	38	26	12	B	10	
63 x 32	401927	25	16	38	22	16	B	10	
75 x 63	401928	50	16	44	38	6	A	28	
75 x 50	418685	40	16	44	31	13	B	28	
75 x 40	418686	32	16	44	26	18	B	28	
90 x 75	401929	65	16	51	44	7	A	36	
90 x 63	418687	50	16	51	38	13	B	36	
90 x 50	418688	40	16	51	31	20	B	36	
110 x 90	401930	80	16	61	51	10	A	16	
110 x 75	418689	65	16	61	44	17	B	16	
110 x 63	418690	50	16	61	38	23	B	16	
125 x 110	401931	100	16	69	61	8	A	24	
125 x 90	418691	80	16	69	51	18	B	12	
125 x 75	420142	65	16	69	44	25	B	12	
140 x 125	401932	110	16	76	69	8	A	20	
140 x 110	418692	100	16	76	61	15	B	10	
160 x 140	401933	125	10	86	76	10	A	12	
160 x 110	418693	100	10	86	61	25	B	6	
200 x 180	401934	160	10	106	96	10	A	6	
200 x 160	401935	150	10	106	86	20	B	6	
225 x 200	401936	175	10	119	106	13	A	7	
225 x 160	401937	150	10	119	86	33	B	7	
250 x 225	401938	200	10	131	119	12	A	6	
250 x 200	401939	175	10	131	106	25	B	6	
315 x 280	410093	-	6	-	-	-	-	3	
315 x 250	401940	225	6	164	131	33	B	3	
315 x 225	401941	200	6	164	119	45	B	3	
400 x 315	405330	300	6	206	163	42	B	1	

Einlegeteile mit Gewinde



DA x IG x L	Art.-Nr.	DN	VE	Preis
50 x 1/2" x 34	40599155	40	10	
63 x 1/2" x 41	40599167	50	10	
50 x 3/4" x 34	40599156	40	10	
63 x 3/4" x 41	40599166	50	10	

T-Stück reduziert 90°, 2 x Klebemuffe, Gewinde

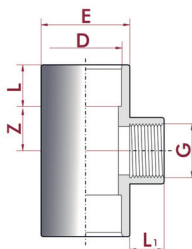

D x G	Art.-Nr.	DN	PN	L	L <sub>1</sub>	Z	E	VE	Preis
50 x 1/2"	401858	40 - 15	10	31	14	26	61	24	
63 x 1/2"	401863	50 - 15	10	38	14	33	76	15	
50 x 3/4"	401857	40 - 20	10	31	16	26	61	24	
63 x 3/4"	401862	50 - 20	16	38	16	33	76	15	





PVC-FITTINGE - CEPEX



Farbe dunkelgrau ca. RAL 7024

Reduktion lang

Klebhemmung / Klebestutzen

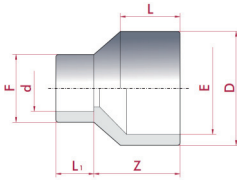

D - E x d	Art.-Nr.	DN	PN	L	L <sub>1</sub>	Z	F	VE	Preis
32-25 x 25	401974	20	16	22	19	30	33	10	
32-25 x 20	401975	15	16	22	16	30	27	10	
40-32 x 32	401976	25	16	26	22	36	38	10	
40-32 x 25	401977	20	16	26	19	36	33	10	
40-32 x 20	401978	15	16	26	16	36	27	10	
50-40 x 40	401979	32	16	31	26	44	48	10	
50-40 x 32	401980	25	16	31	22	44	41	10	
50-40 x 25	401981	20	16	31	19	44	33	10	
50-40 x 20	401982	15	16	31	16	44	27	10	
63-50 x 50	401983	40	16	38	31	54	61	20	
63-50 x 40	401984	32	16	38	26	54	50	46	
63-50 x 32	401985	25	16	38	22	54	41	30	
63-50 x 25	401986	20	16	38	19	54	33	30	
63-50 x 20	401987	15	16	38	16	54	27	30	
75-63 x 63	401988	50	16	44	38	62	73	26	
75-63 x 50	401989	40	16	44	31	62	61	40	
75-63 x 40	401990	32	16	44	26	62	50	40	
75-63 x 32	401991	25	16	51	44	74	87	40	
90-75 x 75	401992	-	16	-	-	-	-	12	
90-75 x 63	401993	50	16	51	38	74	75	34	
90-75 x 50	401994	40	16	51	31	74	61	48	
90-75 x 40	401995	32	16	51	26	74	50	24	
110-90 x 90	401996	80	16	61	51	88	105	16	
110-90 x 75	401997	65	16	61	44	88	90	18	
110-90 x 63	401998	50	16	61	38	88	75	27	
110-90 x 50	401999	40	16	61	31	88	61	27	
125-110 x 90	402000	80	16	69	51	100	105	18	
125-110 x 75	402001	65	16	69	44	100	90	18	
125-110 x 63	402002	50	16	69	38	100	75	20	
140-125 x 110	402003	100	16	76	61	111	130	9	
140-125 x 90	402004	80	16	76	51	111	105	12	
140-125 x 75	402005	65	16	76	44	111	90	12	
160-140 x 125	402006	110	10	86	69	126	148	11	
160-140 x 110	402007	100	10	86	61	126	130	14	
160-140 x 90	402008	80	10	86	51	126	105	18	
200-180 x 140	402009	125	10	106	76	154	157	6	
200-180 x 125	402010	110	10	106	69	154	148	6	
200-180 x 110	402011	100	10	106	61	154	130	6	
225-200 x 160	402012	150	10	119	86	171	180	3	
225-200 x 140	402013	125	10	119	76	171	160	3	
225-200 x 125	402014	110	10	119	69	171	148	4	
250-225 x 200	402015	175	10	131	106	194	225	2	
250-225 x 160	402016	150	10	131	86	194	180	2	
250-225 x 140	402017	125	10	131	76	194	157	3	
315-280 x 200	402018	175	6	164	106	233	225	2	
315-280 x 160	402019	150	6	164	86	233	180	2	

Reduktion lang exzentrisch

Klebhemmung / Klebestutzen

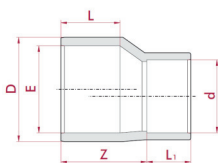

D - E x d	Art.-Nr.	DN	PN	L	L <sub>1</sub>	Z	VE	Preis
90 - 75 x 63	409030	50	16	51	38	74	12	



PVC-FITTINGE - CEPEX



Farbe dunkelgrau ca. RAL 7024

Bundbuchse glatt PVC-U

Klebemuffe

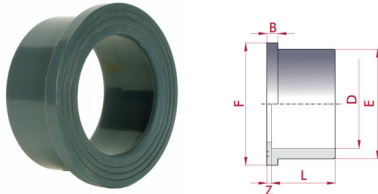

D	Art.-Nr.	DN	PN	L	Z	B	E	F	VE	Preis
20	407692	15	16	16	3	6	27	34	20	
25	407693	20	16	19	3	7	33	41	20	
32	407694	25	16	22	3	7	41	50	20	
40	407695	32	16	26	3	8	50	61	10	
50	402020	40	16	31	3	8	61	73	40	
63	402021	50	16	38	3	9	76	90	18	
75	402022	65	16	44	3	10	90	106	29	
90	402023	80	16	51	5	11	108	125	14	
110	402024	100	16	61	5	12	131	150	20	
125	402025	110	16	69	5	13	148	168	14	
140	402026	125	16	76	5	14	165	188	10	
160	402027	150	10	86	5	16	188	213	12	
200	402028	175	10	106	6	20	225	247	7	
225	402029	200	10	119	6	25	248	274	6	
250	402030	225	10	131	8	27	282	328	5	
315	402031	300	10	164	8	30	342	378	3	
400	405341	375	6	206	12	30	432	483	2	
500	405342	480	4	153	8	24	532	574	1	

Losflansch PVC-U

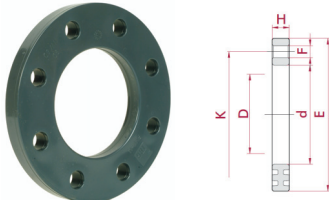

D	Art.-Nr.	DN	PN	d	E	H	K	F	VE	Preis
20	407696	15	16	28	95	12	65	14 x 4	10	
25	407697	20	16	34	105	13	75	14 x 4	10	
32	407698	25	16	42	115	15	85	14 x 4	10	
40	407699	32	16	51	140	16	100	18 x 4	22	
50	402032	40	16	62	150	17	110	18 x 4	18	
63	402033	50	16	78	165	18	125	18 x 4	20	
75	402034	65	16	92	185	22	145	18 x 4	15	
90	402035	80	16	110	200	23	160	18 x 8	34	
110	402036	100	16	133	220	24	180	18 x 8	22	
125	402037	110	16	150	230	26	190	18 x 8	18	
140	402038	125	16	167	250	28	210	18 x 8	16	
140 x 125	402039	110	16	149	250	28	210	18 x 8	16	
160	402040	150	10	190	285	31	240	22 x 8	12	
200	402041	175	10	227	315	32	270	22 x 8	8	
225	402042	200	10	250	340	32	295	22 x 8	5	
225 x 200	409039	175	10	227	342	32	295	22 x 8	5	
250	402043	225	10	285	399	34	350	22 x 12	6	
315	402044	300	10	345	450	36	400	22 x 12	6	
400	405343	375	6	438	572	34	515	25 x 16	2	
500	405344	480	4	533	657	30	600	25 x 20	2	

Blindflansch PVC-U

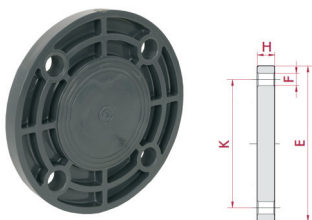

D	Art.-Nr.	DN	PN	H	E	K	F	VE	Preis
20	422561	15	16	11	95	65	14 x 4	10	
25	422562	20	16	12	105	75	14 x 4	10	
32	422563	25	16	14	115	85	14 x 4	10	
40	422564	32	16	15	142	100	18 x 4	20	
50	422565	40	16	16	152	110	18 x 4	16	
63	422566	50	16	18	165	125	18 x 4	10	
75	422567	65	16	19	185	145	18 x 4	7	
90	422568	80	16	20	200	160	18 x 8	10	
110	422569	100	16	22	220	180	18 x 8	6	
125	422570	110	16	24	230	190	18 x 8	5	
140	422571	125	16	26	250	210	18 x 8	5	
160	422572	150	10	28	285	240	22 x 8	5	
200	422573	175	10	30	340	295	22 x 8	5	
225	422574	200	10	30	340	295	22 x 8	4	



PVC-FITTINGE - CEPEX



Farbe dunkelgrau ca. RAL 7024

Flachdichtung aus EVA

(D400 / D500: EPDM)

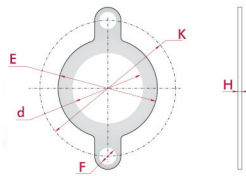

D	Art.-Nr.	DN	d	E	H	K	F	VE	Preis
20	407700	15	20	32	2	65	14	20	
25	407701	20	25	39	2	75	14	20	
32	407702	25	32	48	2	85	14	20	
40	407703	32	40	59	2	100	18	20	
50	402061	40	50	71	3	110	18	20	
63	402062	50	63	88	3	125	18	20	
75	402063	65	75	104	3	145	18	10	
90	402064	80	90	123	3	160	18	20	
110	402065	100	110	148	4	180	18	20	
125	402066	110	125	166	4	190	18	10	
140	402067	125	140	186	4	210	18	10	
160	402068	150	160	211	4	240	22	40	
200	402069	175	200	245	5	270	22	30	
225	402070	200	225	275	5	295	22	30	
250	402071	225	250	328	3	350	22	10	
315	402072	300	315	378	3	400	22	6	
400	405345	353	438	572	3	-	-	6	
500	405346	475	533	657	3	-	-	6	

Flanschsatz  
Klebemuffe

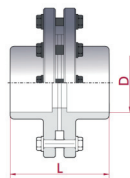

D	Art.-Nr.	DN	PN	L	VE	Preis
75	402371	65	10	97	3	
90	402372	80	10	115	2	
110	402373	100	10	136	3	
125	402374	110	10	152	3	
140	402375	125	10	166	2	
160	402376	150	6	186	2	
200	402377	175	6	227	1	
225	402378	200	6	255	1	

Schrauben, Muttern und U-Scheiben

Stahl 5.6 verzinkt



M	Art.-Nr.	A/DIN931	B/DIN934	C/DIN125	VE	Preis
M 12 x 60	416061	M 12 x 60	M 12	Ø 12	4	
M 16 x 70	402437	M 16 x 70	M 16	Ø 16	8	
M 16 x 80	402438	M 16 x 80	M 16	Ø 16	8	
M 16 x 90	402439	M 16 x 90	M 16	Ø 16	8	
M 16 x 120	402440	M 16 x 120	M 16	Ø 16	4	
M 16 x 130	402441	M 16 x 130	M 16	Ø 16	8	
M 16 x 140	402442	M 16 x 140	M 16	Ø 16	4	
M 16 x 150	402443	M 16 x 150	M 16	Ø 16	4	
M 16 x 160	402444	M 16 x 160	M 16	Ø 16	8	
M 16 x 170	402445	M 16 x 170	M 16	Ø 16	4	
M 16 x 200	407718	M 16 x 200	M 16	Ø 16	4	
M 16 x 220	407719	M 16 x 220	M 16	Ø 16	4	
M 16 x 240	407720	M 16 x 240	M 16	Ø 16	4	
M 20 x 90	402446	M 20 x 90	M 20	Ø 20	8	
M 20 x 110	402447	M 20 x 110	M 20	Ø 20	8	
M 20 x 160	402448	M 20 x 160	M 20	Ø 20	8	
M 20 x 180	402449	M 20 x 180	M 20	Ø 20	8	
M 20 x 190	402450	M 20 x 190	M 20	Ø 20	8	
M 20 x 200	420263	M 20 x 200	M 20	Ø 20	8	
M 20 x 210	402451	M 20 x 210	M 20	Ø 20	8	
M 20 x 230	402452	M 20 x 230	M 20	Ø 20	8	
M 20 x 270	407721	M 20 x 270	M 20	Ø 20	4	
M 20 x 310	407722	M 20 x 310	M 20	Ø 20	4	
M 20 x 340	407723	M 20 x 340	M 20	Ø 20	4	



PVC-FITTINGE - CEPEX



Farbe dunkelgrau ca. RAL 7024

**Kappe**  
Klebhemme

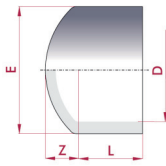

D	Art.-Nr.	DN	PN	L	Z	E	VE	Preis
16	401942	10	16	14	7	22	20	
20	401943	15	16	16	8	25	20	
25	401944	20	16	19	9	32	20	
32	401945	25	16	22	10	40	20	
40	401946	32	16	26	12	50	10	
50	401947	40	16	31	15	63	48	
63	401948	50	16	38	17	75	24	
75	401949	65	16	44	19	90	32	
90	401950	80	16	51	23	110	16	
110	401951	100	16	61	28	131	9	
125	401952	110	16	69	32	148	15	
140	401953	125	16	76	36	163	10	
160	401954	150	10	86	40	185	6	
200	401955	175	10	106	46	224	6	
225	401956	200	10	119	50	252	4	
250	415776	225	10	131	60	282	4	
315	415777	300	10	164	70	357	2	

**Stopfen**  
IG

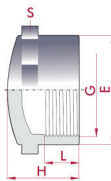

G	Art.-Nr.	DN	PN	L	E	H	S	VE	Preis
3/8"	401957	10	10	14	24	20	24	20	
1/2"	401958	15	10	14	27	23	27	20	
3/4"	401959	20	10	16	33	28	33	20	
1"	401960	25	10	19	41	33	41	10	
1 1/4"	401961	32	10	20	50	36	50	10	
1 1/2"	401962	40	10	20	61	43	61	40	
2"	401963	50	10	24	75	50	75	22	
2 1/2"	401964	65	10	44	90	64	90	12	
3"	401965	80	10	51	108	76	108	16	
4"	401966	100	10	61	135	91	135	8	

**Stopfen**  
AG

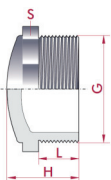

G	Art.-Nr.	DN	PN	L	H	S	VE	Preis
1/4"	402121	8	10	10	18	12	20	
3/8"	402122	10	10	10	22	20	20	
1/2"	402123	15	10	14	27	27	20	
3/4"	402124	20	10	16	30	32	20	
1"	402125	25	10	19	34	36	20	
1 1/4"	402126	32	10	21	36	46	10	
1 1/2"	402127	40	10	21	37	55	60	
2"	402128	50	10	26	42	65	70	
2 1/2"	402129	65	10	30	50	80	45	
3"	402130	80	10	33	59	93	33	
4"	402131	100	10	38	68	115	12	





PVC-FITTINGE - CEPEX



Farbe dunkelgrau ca. RAL 7024

Übergangsmuffennippel

Klebemuffe / AG

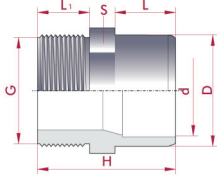

D - d x G	Art.-Nr.	DN	PN	L	L <sub>1</sub>	H	S	VE	Preis
16 - 12 x 3/8"	402073	12	10	14	11	35	24	20	
20 - 16 x 1/2"	402074	15	10	16	14	42	27	20	
20 - 16 x 3/8"	402075	12	10	16	11	39	27	20	
25 - 20 x 3/4"	402076	20	10	19	16	47	32	20	
25 - 20 x 1/2"	402077	15	10	19	14	45	32	20	
25 - 20 x 3/8"	402078	12	10	19	11	42	32	20	
32 - 25 x 1"	402079	25	10	22	19	54	36	20	
32 - 25 x 3/4"	402080	20	10	22	16	51	36	20	
32 - 25 x 1/2"	402081	15	10	22	14	49	36	20	
40 - 32 x 1 1/4"	402082	32	10	26	21	60	46	10	
40 - 32 x 1"	402083	25	10	26	19	58	46	10	
40 - 32 x 3/4"	402084	20	10	26	16	55	46	10	
50 - 40 x 1 1/2"	402085	40	10	31	25	70	55	68	
50 - 40 x 1 1/4"	402086	32	10	31	21	66	55	68	
50 - 40 x 1"	402087	25	10	31	19	64	55	10	
63 - 50 x 2"	402088	50	10	38	25	78	65	46	
63 - 50 x 1 1/2"	402089	40	10	38	21	73	65	60	
63 - 50 x 1 1/4"	402090	32	10	38	21	73	65	60	
75 - 63 x 2 1/2"	402091	65	10	44	30	89	78	24	
75 - 63 x 2"	402092	50	10	44	25	84	78	30	
75 - 63 x 1 1/2"	402093	40	10	44	21	80	78	30	
90 - 75 x 3"	402094	80	10	51	33	99	93	12	
90 - 75 x 2 1/2"	402095	65	10	51	30	96	93	15	
90 - 75 x 2"	402096	50	10	51	25	91	93	24	
110 - 90 x 4"	402097	100	10	61	40	116	120	6	
110 - 90 x 3"	402098	80	10	61	33	109	120	9	
110 - 90 x 2 1/2"	402099	65	10	61	30	106	120	9	

Übergangsmuffe

Klebemuffe / AG

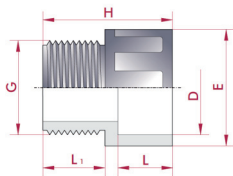

D x G	Art.-Nr.	DN	PN	L	L <sub>1</sub>	E	H	VE	Preis
120 x 1/2"	402102	15	10	16	14	28	38	20	
25 x 3/4"	402103	20	10	19	16	34	42	20	
32 x 1"	402104	25	10	22	19	41	50	20	
40 x 1 1/4"	402105	32	10	26	21	51	55	10	
50 x 1 1/2"	402106	40	10	31	22	62	65	72	
63 x 2"	402107	50	10	38	27	77	75	50	
75 x 2 1/2"	402108	65	10	44	30	90	85	24	
90 x 3"	402109	80	10	51	33	108	98	28	
110 x 4"	402110	100	10	61	40	131	115	10	

Doppelnippel

AG / AG

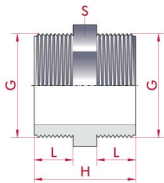

D	Art.-Nr.	DN	PN	L	H	S	VE	Preis
3/8"	402111	10	10	11	32	20	20	
1/2"	402112	15	10	14	40	27	20	
3/4"	402113	20	10	16	44	32	20	
1"	402114	25	10	19	51	36	20	
1 1/4"	402115	32	10	21	55	46	10	
1 1/2"	402116	40	10	21	56	55	36	
2"	402117	50	10	26	66	65	46	
2 1/2"	402118	65	10	30	75	90	30	
3"	402119	80	10	33	81	108	12	
4"	402120	100	10	38	91	135	6	



PVC-FITTINGE - CEPEX



Farbe dunkelgrau ca. RAL 7024

Übergangsmuffennippel

Klebemuffe / IG

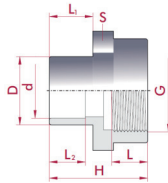

D - d x G	Art.-Nr.	DN	PN	L	L <sub>1</sub>	L <sub>2</sub>	H	S	VE	Preis
20 - 16 x 3/4"	402243	16	10	19	16	14	44	32	20	
20 - 16 x 1/2"	402244	16	10	18	16	14	43	32	20	
20 - 16 x 3/8"	402245	12	10	14	16	14	39	32	20	
20 - 16 x 1/4"	402246	12	10	12	16	14	37	32	20	
25 - 20 x 1"	402247	20	10	22	19	16	50	36	10	
25 - 20 x 3/4"	402248	20	10	19	19	16	46	32	10	
25 - 20 x 1/2"	402249	-	10	-	-	-	-	-	10	
32 - 25 x 1 1/4"	402250	25	10	25	22	19	56	46	10	
32 - 25 x 1"	402251	25	10	22	22	19	53	36	10	
32 - 25 x 3/4"	402252	20	10	19	22	19	50	36	10	
32 - 25 x 1/2"	424822	16	10	18	22	19	49	36	10	
40 - 32 x 1 1/2"	402253	32	10	25	26	22	60	55	10	
40 - 32 x 1 1/4"	402254	32	10	25	26	22	60	46	10	
40 - 32 x 1"	402255	25	10	22	26	22	57	46	10	
50 - 40 x 2"	402256	40	10	29	31	26	69	65	45	
50 - 40 x 1 1/2"	402257	40	10	25	31	26	65	55	10	
50 - 40 x 1 1/4"	402258	32	10	25	31	26	65	55	10	
63 - 50 x 2 1/2"	402259	50	10	34	38	31	81	78	24	
63 - 50 x 2"	402260	50	10	29	38	31	76	65	36	
63 - 50 x 1 1/2"	402261	40	10	25	38	31	72	65	36	
75 - 63 x 3"	402262	50	10	37	44	38	96	108	16	
75 - 63 x 2 1/2"	402263	65	10	34	44	38	87	78	12	
75 - 63 x 2"	402264	50	10	29	44	38	82	78	24	
90 - 75 x 4"	402265	65	10	42	51	44	124	135	10	
90 - 75 x 3"	402266	65	10	36	51	44	98	108	9	
90 - 75 x 2 1/2"	402267	65	10	33	51	44	92	90	9	
110 - 90 x 4"	402268	80	10	42	61	51	116	135	6	
110 - 90 x 3"	402269	80	10	36	61	51	105	110	6	

Druckschlauchtülle

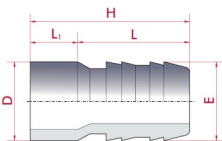

D x E	Art.-Nr.	PN	H	L <sub>1</sub>	L	E	VE	Preis
16 x 16	402200		10	49	14	35	16	20
20 x 18	402201		10	51	16	35	18	20
20 x 20	402202		10	54	16	38	20	20
25 x 25	402203		10	61	19	42	25	20
32 x 30	402204		10	69	22	47	30	20
40 x 40	402205		10	78	26	52	40	10
50 x 50	402206		10	88	31	57	50	30
50 x 38	402207		10	88	31	57	38	40
63 x 60	402208		10	98	38	60	61	18

Druckschlauchtülle

AG

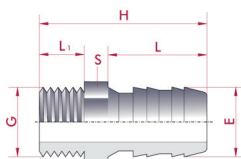

G x E	Art.-Nr.	PN	H	L <sub>1</sub>	S	L	E	VE	Preis
3/8" x 16	402217	10	54	11	35	18	16	20	
1/2" x 18	402218	10	58	15	35	22	18	20	
1/2" x 20	402219	10	60	15	38	22	20	20	
3/4" x 25	402220	10	67	17	42	27	25	20	
3/4" x 20	415763	10	62	17	36	27	20	20	
1" x 30	402221	10	78	21	47	36	30	20	
1" x 25	409031	10	78	21	47	36	25	20	
1 1/4" x 40	402222	10	84	22	52	46	40	10	
1 1/2" x 50	402223	10	89	22	57	50	50	30	
1 1/2" x 38	402224	10	89	22	57	50	38	36	
1 1/2" x 40	409032	10	89	22	57	50	40	36	
2" x 60	402225	10	100	26	60	65	61	15	



PVC-FITTINGE - CEPEX



Farbe dunkelgrau ca. RAL 7024

Reduziernippel

AG / IG

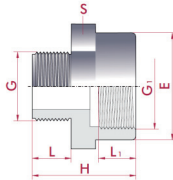

G x G <sub>1</sub>	Art.-Nr.	DN	PN	L	L <sub>1</sub>	H	E	S	VE	Preis
3/8" x 1/2"	402270	10	10	11	18	42	28	27	20	
1/2" x 3/4"	402271	15	10	15	19	49	35	33	20	
1/2" x 3/8"	402272	10	10	15	14	38	22	22	20	
3/4" x 1"	402273	20	10	16	22	46	41	41	10	
3/4" x 1/2"	402274	15	10	16	18	43	28	32	10	
3/4" x 3/8"	402275	10	10	16	14	39	22	33	10	
1" x 1 1/4"	402276	25	10	19	25	53	50	50	10	
1" x 3/4"	402277	20	10	19	19	48	33	36	10	
1" x 1/2"	402278	15	10	19	18	47	28	36	10	
1" x 3/8"	402279	10	10	19	14	43	22	36	10	
1 1/4" x 1 1/2"	402280	32	10	21	25	54	61	61	40	
1 1/4" x 1"	402281	25	10	21	25	52	41	46	10	
1 1/4" x 3/4"	402282	20	10	21	22	50	33	46	10	
1 1/4" x 1/2"	402283	15	10	21	18	49	28	46	10	
1 1/2" x 2"	402284	40	10	21	29	60	75	75	18	
1 1/2" x 1 1/4"	402285	32	10	21	25	55	50	55	10	
1 1/2" x 1"	402286	25	10	21	22	53	41	55	10	
1 1/2" x 3/4"	402287	20	10	21	19	51	33	55	10	
2" x 2 1/2"	402288	50	10	25	34	68	90	90	36	
2" x 1 1/2"	402289	40	10	25	25	59	61	65	48	
2" x 1 1/4"	402290	32	10	25	25	59	50	65	48	
2" x 1"	402291	25	10	25	22	57	41	65	10	
2 1/2" x 3"	402292	65	10	30	37	99	108	108	16	
2 1/2" x 2"	402293	50	10	30	29	68	75	80	32	
2 1/2" x 1 1/2"	402294	40	10	30	25	64	61	80	32	
2 1/2" x 1 1/4"	402295	32	10	30	25	64	50	80	40	
3" x 4"	402296	80	10	33	43	115	135	135	12	
3" x 2 1/2"	402297	63	10	33	34	75	90	93	24	
3" x 2"	402298	50	10	33	29	70	75	93	24	
3" x 1 1/2"	402299	40	10	33	25	66	61	93	24	
4" x 3"	402300	80	10	39	37	91	108	115	9	
4" x 2 1/2"	402301	65	10	39	34	93	90	115	12	
4" x 2"	402302	50	10	39	29	100	75	115	12	

Reduziernippel

AG / AG

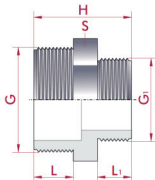

G x G <sub>1</sub>	Art.-Nr.	DN	PN	L	L <sub>1</sub>	H	S	VE	Preis
1/2" x 3/8"	402303	10	10	15	11	36	24	20	
3/4" x 1/2"	402304	15	10	16	15	43	32	20	
3/4" x 3/8"	402305	10	10	16	11	39	32	20	
1" x 3/4"	402306	20	10	19	16	48	40	10	
1" x 1/2"	402307	15	10	19	15	47	40	10	
1" x 3/8"	402308	10	10	19	11	43	40	10	
1 1/4" x 1"	402309	25	10	21	19	53	50	10	
1 1/4" x 3/4"	402310	20	10	21	16	50	50	10	
1 1/4" x 1/2"	402311	15	10	21	15	49	50	10	
1 1/2" x 1 1/4"	402312	32	10	21	21	56	55	38	
1 1/2" x 1"	402313	25	10	21	19	54	55	60	
1 1/2" x 3/4"	402314	20	10	21	16	51	55	60	
2" x 1 1/2"	402315	40	10	25	21	61	65	24	
2" x 1 1/4"	402316	32	10	25	21	61	65	33	
2" x 1"	402317	25	10	25	19	58	65	33	
2 1/2" x 2"	402318	50	10	30	25	70	80	30	
2 1/2" x 1 1/2"	402319	40	10	30	21	66	80	45	
2 1/2" x 1 1/4"	402320	32	10	30	21	66	80	45	
3" x 2 1/2"	402321	65	10	33	30	78	93	24	
3" x 2"	402322	50	10	33	25	73	93	24	
3" x 1 1/2"	402323	40	10	33	21	69	93	36	
4" x 3"	402324	80	10	38	33	86	115	12	
4" x 2 1/2"	402325	65	10	38	30	83	115	12	
4" x 2"	402326	50	10	38	25	78	115	12	



PVC-FITTINGE - CEPEX



Farbe dunkelgrau ca. RAL 7024

Einschraubteil Klebemuffe / AG

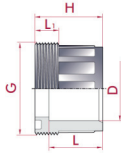

D x G	Art.-Nr.	DN	PN	L	L <sub>1</sub>	H	VE	Preis
20 x 1"	402148	15	10	16	10	26	50	
25 x 1 1/4"	402150	20	10	19	11	29	25	
32 x 1 1/2"	402151	25	10	22	12	32	200	
40 x 2"	402153	32	10	28	15	39	60	
50 x 2 1/4"	402154	40	10	31	16	46	80	
63 x 2 3/4"	402156	50	10	38	18	56	46	
75 x 3 1/2"	402157	65	10	44	18	62	15	
90 x 4"	402158	80	10	51	18	69	20	
110 x 5 1/2"	402159	100	10	61	31	79	15	

Einlegeteil Klebemuffe

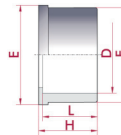

D	Art.-Nr.	DN	PN	L	E	H	F	VE	Preis
16	420229	10	16	14	24	17	22	5	
20	402172	15	16	16	30	19	27	300	
25	402173	20	16	19	39	22	36	200	
32	402174	25	16	22	45	25	41	125	
40	402175	32	16	26	56	29	53	60	
50	402176	40	16	31	63	34	59	50	
63	402177	50	16	38	78	41	74	60	
75	402178	65	16	44	97	47	92	35	
90	402179	80	16	51	110	56	105	18	
110	402180	100	16	61	147	66	131	10	

Einlegeteil IG

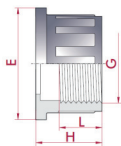

G	Art.-Nr.	DN	PN	L	H	E	VE	Preis
3/8"	420230	10	10	12	17	24	50	
1/2"	416310	15	10	15	21	30	300	
3/4"	416311	20	10	17	23	39	200	
1"	416312	25	10	20	26	45	40	
1 1/4"	416313	32	10	24	30	56	60	
1 1/2"	416314	40	10	25	35	63	50	
2"	416315	50	10	29	42	78	20	
2 1/2"	416316	65	10	34	48	97	15	
3"	416317	80	10	37	57	110	20	
4"	416318	100	10	42	69	146	15	

Überwurfmutter IG

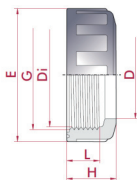

G	Art.-Nr.	PN	L	H	E	D	Di	VE	Preis
3/4"	402187	10	15	20	36	22	24	300	
1"	402188	10	15	20	41	27	30	200	
1 1/4"	402189	10	16	22	52	36	39	100	
41,5	402190	10	12	18	53	33	39	200	
1 1/2"	402191	10	20	26	60	41	45	70	
2"	402192	10	21	26	74	53	57	45	
2 1/4"	402193	10	22	30	80	59	63	35	
2"	402194	10	19	28	70	46	54	90	
2 1/2"	402195	10	18	27	90	64	72	36	
2 3/4"	402196	10	28	36	99	74	78	40	
3 1/2"	402197	10	28	36	120	92	97	30	
4"	402198	10	28	38	133	105	110	16	
5 1/2"	402199	10	41	56	177	131	148	15	

O-Ringe - EPDM

für Verschraubungen PVC



G	Art.-Nr.	DN	VE	Preis
20 x 1/2"	041003	15	1	
25 x 3/4"	041013	20	1	
32 x 1"	041023	25	1	
40 x 1 1/4"	041033	32	1	
50 x 1 1/2"	041043	40	1	
63 x 2"	041053	50	1	
75 x 2 1/2"	041063	65	1	
90 x 3"	041073	80	1	
110 x 4"	041083	90	1	



## ANBOHRSCHELLEN - CEPEX



Farbe dunkelgrau ca. RAL 7024

Anbohrschellen  
mit Verstärkungsring

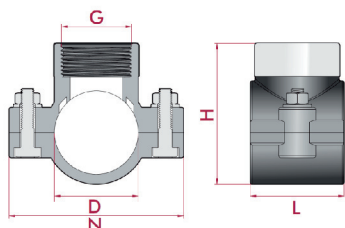

Größe	Art.-Nr.	PN	N	L	H	Schrauben	VE	Preis
25 x 1/2"	411435	10	67	24	52,5	2	100	
25 x 3/4"	402379	10	67	24	52,5	2	100	
32 x 1/2"	411436	10	79	31	61,5	2	60	
32 x 3/4"	411437	10	79	31	61,5	2	60	
32 x 1"	402380	10	79	31	67,5	2	30	
40 x 1/2"	411438	10	85	50	74,5	2	40	
40 x 3/4"	411439	10	85	50	74,5	2	40	
40 x 1"	402381	10	85	50	74,5	2	40	
50 x 1/2"	411440	10	103	52	84,5	2	70	
50 x 3/4"	411441	10	103	52	84,5	2	70	
50 x 1"	402382	10	103	52	84,5	2	70	
50 x 1 1/4"	428678	10	103	52	84,5	2	70	
63 x 1/2"	428679	10	101	70	103,5	4	50	
63 x 3/4"	411442	10	101	70	103,5	4	50	
63 x 1"	402383	10	101	70	103,5	4	50	
63 x 1 1/4"	428680	10	101	70	103,5	4	40	
63 x 1 1/2"	411443	10	101	70	103,5	4	40	
75 x 1/2"	411444	10	114	75	113	4	50	
75 x 3/4"	411445	10	114	75	113	4	50	
75 x 1"	402384	10	114	75	113	4	50	
75 x 1 1/4"	428681	10	114	75	113	4	50	
75 x 1 1/2"	411446	10	114	75	113	4	50	
90 x 1/2"	411447	10	125	84,5	129	4	40	
90 x 3/4"	411448	10	125	84,5	129	4	40	
90 x 1"	402385	10	125	84,5	129	4	40	
90 x 1 1/4"	411449	10	125	84,5	129	4	40	
90 x 1 1/2"	411450	10	125	84,5	129	4	40	
90 x 2"	436878	10					40	
110 x 1"	402386	10	150	99	151	4	40	
110 x 1 1/2"	411451	10	150	99	151	4	40	
110 x 2"	411452	10	150	99	151	4	40	
125 x 1"	411453	10	171	99,5	167	4	35	
125 x 1 1/2"	411454	10	171	99,5	167	4	35	
125 x 2"	411455	10	171	99,5	167	4	35	
140 x 1"	406022	10	180	137	188,5	6	25	
140 x 1 1/2"	406024	10	180	137	188,5	6	25	
140 x 2"	406025	10	180	137	188,5	6	25	
140 x 3"	406026	10	180	137	188,5	6	20	
160 x 1"	406027	10	208	137	213	6	20	
160 x 1 1/2"	406029	10	208	137	213	6	20	
160 x 2"	406030	10	208	137	213	6	20	
160 x 3"	406031	10	208	137	213	6	15	

### Rohrklemmen PP

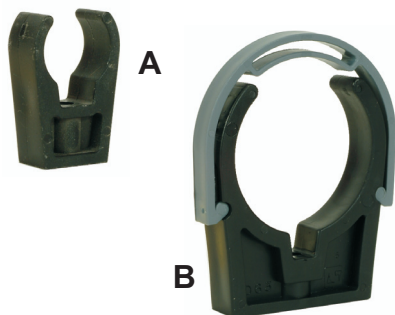

Typ	Art.-Nr.	DN	DA	VE	Preis
A	402132	16	20	150	
A	402133	20	25	110	
A	402134	25	32	90	
A	402135	32	40	100	
B	402140	40	50	110	
B	402141	50	63	70	
B	402142	63	75	90	
B	402143	75	90	54	
B	408916	90	110	20	
B	408917	100	125	18	
B	410956	110	140	13	
B	408918	140	160	10	
B	410958	200	225	6	





## FLEXIBLE FITTINGE

Die ideale Lösung für Anwendungen, bei denen Kleben nicht möglich oder nicht erwünscht ist. Geeignet für den mehrfachen Gebrauch. Auch wenn die Rohrverbindung nicht rechtwinklig oder gerade ist, passen sich diese Fittings an.

Material: PVC Elastomer. PVC Elastomer hat eine sehr starke Zug- und Reißfestigkeit, ist enorm flexibel und nicht der Alterung unterworfen ("verkauschucken").

Außenrohr	Außenrohr	Außen Druckfitting	Klemmbereich
1¼"	40mm	32	41-38 mm
1½"	50mm	40	50-44 mm
2"	63mm	50	63-57 mm
3"	90mm	75	90-82 mm
4"	110mm	90	110-100 mm

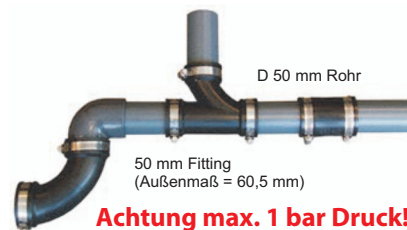

**Gruppe B**  
exkl. MWSt.



### FLEXIBLE MUFFE

Art. Nr.	Masse	Klemmbereich	VE	Preis
SBFC119	1¼" / 40mm	41-38 mm	100	
SBFC120	1½" / 50mm	50-44 mm	100	
SBFC122	2" / 63mm	63-57 mm	100	
SBFC126	3" / 90mm	90-82 mm	80	
SBFC128	4" / 110mm	110-100 mm	60	



### FLEXIBLE REDUZIERMUFFE

Art. Nr.	Masse	VE	Preis
SBFC140	1½" x 1¼" / 50 x 40mm	100	
SBFC142	2" x 1½" / 63 x 50mm	100	
SBFC146	3" x 2" / 90 x 63mm	80	
SBFC147	4" x 2" / 110 x 63mm	60	
SBFC148	4" x 3" / 110 x 90mm	60	



### FLEXIBLES T-STÜCK

Art. Nr.	Masse	Klemmbereich	VE	Preis
SBFC150	1½" / 50mm	50-44 mm	50	
SBFC152	2" / 63mm	63-57 mm	20	
SBFC156	3" / 90mm	90-82 mm	20	
SBFC158	4" / 110mm	110-100 mm	6	



### FLEXIBLE ENDKAPPE

Art. Nr.	Masse	Klemmbereich	VE	Preis
SBFC160	1½" / 50mm	50-44 mm	160	
SBFC162	2" / 63mm	63-57 mm	150	
SBFC166	3" / 90mm	90-82 mm	100	
SBFC168	4" / 110mm	110-100 mm	80	



### FLEXIBLER BOGEN

Art. Nr.	Masse	Klemmbereich	VE	Preis
SBFC170	1½" / 50mm	50-44 mm	50	
SBFC172	2" / 63mm	63-57 mm	20	
SBFC176	3" / 90mm	90-82 mm	20	
SBFC178	4" / 110mm	110-100 mm	6	



## SCHWIMMBADKUGELHÄHNE PVC - PRAHER

€ **Gruppe A**  
exkl. MWSt.

### S6 - SAFETY STANDARD

Material: **PVC / PN 10**

Kugelsitzring: **PE**

Dichtung: **EPDM**



DN	Art.-Nr.	PN	DA	Preis
10	08130	S6	16	16
15	08131	S6	16	20
20	08132	S6	16	25
25	08133	S6	16	32
32	08134	S6	16	40
40	08135	S6	16	50
50	08136	S6	16	63

**PE-Schweißanschluss metrisch  
mit PE-Kugeldichtung  
O-Ring EPDM**



DN	Art.-Nr.	PN	DA	Preis
40	08145	S6	16	50
50	08146	S6	16	63

## PVC-RÜCKSCHLAGVENTILE PRAHER KLEBESTUTZEN S4

**Rückschlagventile Typ S 4 / EPDM Dutral**

Material: **PVC Industrie Klebemuffe**

Dichtung: **EPDM**

Industrie-Ausführung - **Federbelastet**



Bezeichnung	DN	Art.-Nr.	PN	DA	Preis
Rückschlagventil S4	40	08055	16	50	
Rückschlagventil S4	50	08056	16	63	

## PVC-RÜCKSCHLAGVENTILE PRAHER KLEBESTUTZEN S6



**Rückschlagventile Typ S 6 / EPDM**  
 Material: **PVC Industrie Klebemuffe**  
**Federbelastet**  
 Dichtung: **EPDM oder FPM**  
 mit 3/4" Innengewinde für Ablassventil



Bezeichnung	DN	Art.-Nr.	PN	DA	Preis
Rückschlagventil S 6	40 x 3/4" IG	<b>08065</b>	16	50 x 3/4"	
Rückschlagventil S 6	50 x 3/4" IG	<b>08066</b>	16	63 x 3/4"	

Rückschlagventil S 6	40	<b>08080</b>	16	50
Rückschlagventil S 6	50	<b>080810</b>	16	63

Rückschlagventil S 6	40 transparent	<b>08083</b>	16	50
Rückschlagventil S 6	50 transparent	<b>08084</b>	16	63

## LABORKUGELHÄHNE PVC INDUSTRIE - PRAHER DN6 / PN 10

**PVC LABORKUGELHAHN PR**  
 Material: **PVC**  
 O-Ringe: **EPDM**  
 O-Ringe: **FPM VITON**



Bezeichnung	Art.Nr.	Gewinde	Preis
Laborkugelhahn PVC-EPDM	<b>08180</b>	1/4" IG x 1/4" AG	

(Mit Set = Tülle, Doppelnippel und Stopfen 1/4" x NW 6/10)

## PVC-ABLASSVENTILE PN 10 PRAHER - CEPEX

Material: **PVC**  
 max. Betriebsdruck: **PN 10**



Bezeichnung	Art.Nr.	Gewinde	Preis
Ablassventil schwarz	<b>080671</b>	3/4" AG x 3/4" AG	
Ablassventil schwarz	<b>080681</b>	3/4" AG x NW 16 (Gardenaanschluss)	
Ablassventil	<b>04116</b>	3/4" IG / 3/4" AG	
Üw.-Mutter und Tülle	<b>04118</b>	3/4" IG x NW 19	
Ablassventil	<b>04468</b>	1/4"AG x NW 10	

## ERSATZTEILE 2-WEGE-SCHWIMMBADKUGELHÄHNE - PRAHER

**Gruppe A**  
exkl. MWSt.

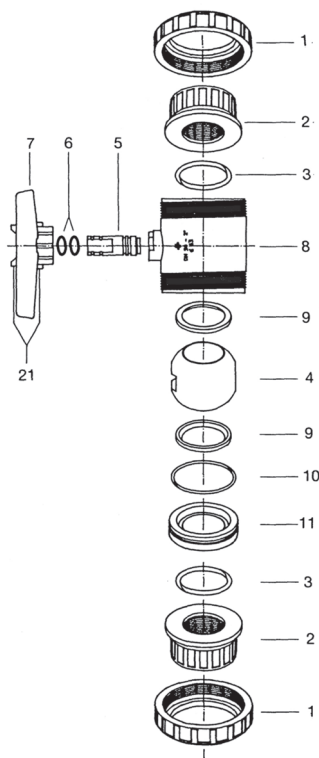

Bezeichnung	DA	Teil-Nr.	Art.-Nr.	Preis
Überwurf-Mutter S 6	50	1	083251	
Überwurf-Mutter S 6	63	1	083261	
Überwurf-Mutter S 4	50	1	321151	
Überwurf-Mutter S 4	63	1	321161	
Überwurf-Mutter	16/20	-	081301	
Überwurf-Mutter	25	-	081321	
Überwurf-Mutter	32	-	081331	
Überwurf-Mutter	40	-	081341	
Überwurf-Mutter	75	-	081371	
Überwurf-Mutter	90	-	081381	
Einlegeteil-Klebe S4/S5	16	2	081302	
Einlegeteil-Klebe S4/S5	20	2	081312	
Einlegeteil-Klebe S4/S5	25	2	081322	
Einlegeteil-Klebe S4/S5	32	2	081332	
Einlegeteil-Klebe S4/S5	40	2	081342	
Einlegeteil-Klebe S4/S5	50	2	081352	
Einlegeteil-Klebe S4/S5	63	2	081362	
Einlegeteil-Klebe S4/S5	75	2	081372	
Einlegeteil-Klebe S4/S5	90	2	081382	
Einlegeteil Schweißstutzen S4/S5	50	2	081452	
Einlegeteil Schweißstutzen S4/S5	63	2	081462	
Einlegeteil Schweißstutzen S4/S5	75	-	081472	
O-Ring-Einlegeteil S4/S5	16/20	3	081303	
O-Ring Einlegeteil S4/S5	25	3	081323	
O-Ring Einlegeteil S4/S5	32	3	081333	
O-Ring Einlegeteil S4/S5	40	3	081343	
O-Ring Einlegeteil S4/S5	50	3	081353	
O-Ring Einlegeteil S4/S5	63	3	081363	
O-Ring Einlegeteil S4/S5	75	3	081373	
O-Ring Einlegeteil S4/S5	90	3	081383	
Einlegeteil S4/S5	3/8" IG	-	081300	
Einlegeteil S4/S5	3/4" IG	-	081320	
Griff für KH	25	-	081327	
Griff für KH	40	-	081347	
Griff für KH	50	-	081357	
Griff für KH	63	-	081367	
Griff für KH	75	-	081377	
Griff für KH	90/110	-	081387	



## PVC-FITTINGE Klebe - PN 10 / schwarz - IBG



### PVC-Fittinge für Schwimmbadbau

Farbe: schwarz

Höchstbetriebsdruck: 10 bar bei 20° C

#### Winkel 90°



Farbe	DN	Art.-Nr.	VE	DA	Preis per Stück
schwarz	40	503104	40	50	

#### Winkel 45°



schwarz	40	504514	40	50	
---------	----	--------	----	----	--

#### T-Stücke egal



schwarz	40	509104	30	50	
---------	----	--------	----	----	--

#### Muffe

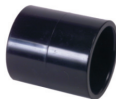

schwarz	40	501054	60	50	
---------	----	--------	----	----	--

#### Reduktionswinkel



schwarz	40	503124	40	50/40	
---------	----	--------	----	-------	--

#### Klebekappe



schwarz	40	654084	150	50	
---------	----	--------	-----	----	--

#### Verschraubung



schwarz	40	500350	40	50 x 1 1/2" AG + O-Ring	
---------	----	--------	----	-------------------------	--

#### Übergangsmuffennippel



schwarz	40	505264	90	50 x 1 1/2" AG	
---------	----	--------	----	----------------	--

## PVC-ROHR PN 10 / schwarz ungemufft - Stangenware

schwarz, aus PVC-hart, ungemufft



Rohrlänge	DN	Art. Nr.	Wandstärke mm	VE	DA	Preis / lfm.
5 lfm	40	402705	2,4	1	50	

Mindestabnahme 5 lfm = Lieferlänge

1 Pall. = 970 m

**Achtung: Die Auslieferung von PN10 PVC-Druckrohren schwarz erfolgt nur in ganzen Stangen!**



## PVC-FITTINGE Klebe - PN 10 / weiß - IBG

### PVC-Fittinge für Schwimmbadbau

Farbe: weiß

Höchstbetriebsdruck: 10 bar bei 20° C

#### Winkel 90°



Farbe	DN	Art.-Nr.	VE	DA	Preis per Stück
weiß	40	503105	40	50	

#### Reduktionswinkel 90°



weiß	40	503125	40	40/50 x 50	
------	----	--------	----	------------	--

#### Winkel 45°



weiß	40	504515	40	50	
------	----	--------	----	----	--

#### T-Stücke egal



weiß	40	509105	30	50	
------	----	--------	----	----	--

#### Muffe / Muffennippel



weiß	40	501055	40	50	
weiß	40	505265	90	50 x 1 1/2" AG	

#### Verschraubungen / Klebe (PN16)



weiß	40	500165	40	50/50	
weiß	40	500300	40	50 x 1 1/2" AG	
weiß	40	500450	32	50 x 2" AG	

## PVC-ROHR PN 10 / weiß ungemufft - Stangenware

aus PVC-hart, ungemufft

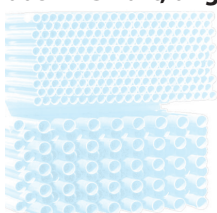

Rohrlänge	DN	Art. Nr.	Wandstärke mm	VE	DA	Preis / lfm.
2 lfm	40	700926	2,4	1	50	

Mindestabnahme 2 lfm = Lieferlänge

**Achtung: Die Auslieferung von PN10 PVC-Druckrohren weiß erfolgt nur in ganzen Stangen!**

## PVC-FITTINGE - PN 16 - IBG



Farbe dunkelgrau RAL 7011

Winkel 90° Klebemuffe



DN	Art.-Nr.	VE	DA	Preis
15	650110	10	20	
20	503070	10	25	
25	503086	10	32	
32	503096	70	40	
40	503106	40	50	
50	503116	70	63	

Reduzierwinkel 45° + 90°



	DN	Art.-Nr.	VE	DA	Preis
Winkel 90°	40	503120 x	40	40/50 x 50	
Winkel 90°	50	503130 x	35	50/63 x 63	
Winkel 45°	40	650380 x	40	40/50 x 50	
Winkel 45°	50	650390 x	40	50/63 x 63	

Winkel 90° verstärkt, DA x IG  
Klebemuffe



DN	Art.-Nr.	VE	DA x IG	Preis
10	601100	10	16 x 3/8"	
15	601110	10	20 x 1/2"	
20	601120	10	25 x 3/4"	
25	650260	10	32 x 1"	
32	650270	10	40 x 1 1/4"	
40	650280	10	50 x 1 1/2"	
50	650290	10	63 x 2"	

Winkel 90° DA x AG  
Klebemuffe



DN	Art.-Nr.	VE	DA x AG	Preis
25	650200 x	100	32 x 1 1/4"	
32	650210 x	70	40 x 1 1/4"	
40	650220 x	10	50 x 1 1/4"	
40	650230 x	10	50 x 1 1/2"	
40	650240 x	10	50 x 2"	

Winkel 45°



DN	Art.-Nr.	VE	DA	Preis
15	601300	5	20	
20	650300	5	25	
25	650310	5	32	
32	650320	5	40	
40	650330	5	50	
50	650340	2	63	



Bitte beachten!  
x = PN 10

PVC-FITTINGE - PN 16 - IBG



Farbe dunkelgrau RAL 7011  
T-Stücke egal 90°



DN	Art.-Nr.	VE	DA	Preis
15	650610	100	20	
20	650620	60	25	
25	650630	10	32	
32	509096	50	40	
40	509106	30	50	
50	509110	30	63	

T-Stücke 90°



DN	Art.-Nr.	VE	DA x IG	Preis
15	602710	10	20 x 1/2"	
20	602720	10	25 x 3/4"	
25	651150	10	32 x 1"	
32	651160	10	40 x 1 1/4"	
40	651170	10	50 x 1 1/2"	
50	651180	5	63 x 2"	
65	602730	2	75 x 2 1/2"	
80	602740	2	90 x 3"	

T-Stücke 45°



DN	Art.-Nr.	VE	DA	Preis
32	602890 x	5	40	
40	602910 x	5	50	
50	602920 x	5	63	

Einlegeteile mit Gewinde



DN	Art.-Nr.	VE	DA x IG	Preis
40	40599155	10	50 x 1/2"	
50	40599167	10	63 x 1/2"	
40	40599156	10	50 x 3/4"	
50	40599166	10	63 x 3/4"	

Muffen



DN	Art.-Nr.	VE	DA	Preis
15	652010	10	20	
20	652020	10	25	
25	652030	10	32	
32	652040	10	40	
40	501050	60	50	
50	501060	50	63	

Reduktionen kurz



DN x dn 1	Art.-Nr.	VE	DA x d1	Preis
20 x 10	654220	10	25 x 16	
20 x 15	654210	10	25 x 20	
25 x 10	654300	10	32 x 16	
25 x 15	654310	10	32 x 20	
25 x 20	654250	10	32 x 25	
32 x 10	654320	10	40 x 16	
32 x 15	654330	10	40 x 20	
40 x 20	654340	10	40 x 25	
32 x 25	654260	10	40 x 32	
40 x 15	654350	250	50 x 20	
40 x 20	654360	250	50 x 25	
40 x 25	654370	10	50 x 32	
40 x 32	654270	250	50 x 40	
50 x 20	654380	120	63 x 25	
50 x 25	654390	120	63 x 32	
50 x 32	654400	120	63 x 40	
50 x 40	654280	120	63 x 50	



Bitte beachten!  
x = PN 10



**PVC-FITTINGE - PN 16 - IBG**

Farbe dunkelgrau RAL 7011  
Übergangs-Muffennippel  
Klebemuffe x AG



DN	Art.-Nr.	VE	DA x AG	Preis
8	603960	10	12/16 x 3/8"	
10	653000	10	16 x 3/8"	
10	603970	10	16/20 x 3/8"	
10	603980	10	16/20 x 1/2"	
15	653010	10	20 x 1/2"	
15	603990	10	20/25 x 1/2"	
20	604080	10	20/25 x 3/4"	
20	653020	10	25/32 x 3/4"	
20	653030	10	25/32 x 1"	
25	653040	10	32/40 x 1"	
25	653050	10	32/40 x 1 1/4"	
32	653060	10	40/50 x 1 1/4"	
32	653070	100	40/50 x 1 1/2"	
40	653080	10	50/--- x 1 1/4"	
40	505260	90	50/--- x 1 1/2"	
40	653200	10	50/--- x 1 1/2" NPT	
40	505270	60	50/--- x 2"	
40	603350	140	50/63 x 1 1/2"	
40	603360	140	50/63 x 2"	
50	653110	140	63/75 x 1 1/4"	
50	653120	140	63/75 x 1 1/2"	
50	505300	140	63/75 x 2"	
50	653140	100	63/75 x 2 1/2"	

Übergangsnippel  
Klebestutzen x AG



DN	Art.-Nr.	VE	DA x AG	Preis
15	653330	10	20 x 1/2"	
20	653340	10	25 x 3/4"	
25	653350	10	32 x 3/4"	
25	653360	10	32 x 1"	
32	653370	10	40 x 1"	
32	653380	10	40 x 1 1/4"	
40	653390	10	50 x 1 1/4"	
40	505400	100	50 x 1 1/2"	
50	653410	40	63 x 1 1/4"	
50	653420	40	63 x 1 1/2"	
50	505450	100	63 x 2"	

Übergangsmuffen  
Klebemuffe x IG



DN	Art.-Nr.	VE	DA x IG	Preis
25	653700 x	10	32 x 1"	
32	653710 x	10	40 x 1 1/4"	
40	653720 x	10	50 x 1 1/2"	
50	653730 x	10	63 x 2"8,20	

Übergangsmuffen  
Klebemuffe x IG verstärkt



DN	Art.-Nr.	VE	DA x IG	Preis
15	603210	10	20 x 1/2"	
20	603220	10	25 x 3/4"	
25	653630	10	32 x 1"	
32	653640	10	40 x 1 1/4"	
40	653650	10	50 x 1 1/2"	
50	653660	5	63 x 2"	
65	603300	5	75 x 2 1/2"	
80	603310	5	90 x 3"	
90	603320	2	110 x 4"	



**Bitte beachten!**  
x = PN 10



PVC-FITTINGE - PN 16 - IBG



Farbe dunkelgrau RAL 7011

Reduktionsnippel  
Klebenippel x IG



DN	Art.-Nr.	VE	DA x IG	Preis
15	603900	10	20 x 3/8"	
20	603910	10	25 x 1/2"	
25	603920	10	32 x 3/4"	
32	603930	10	40 x 1"	
40	603940	10	50 x 1 1/4"	
50	603950	10	63 x 1 1/2"	

Übergangsstücke  
Klebemuffe / Nippel x IG



DN	Art.-Nr.	VE	DA x IG	Preis
15-10	604110 x	10	20/16 x 1/2"	
20-15	604120 x	10	25/20 x 3/4"	
25-20	604130 x	10	32/25 x 1"	
32-25	604140 x	10	40/32 x 1 1/4"	
40-32	604150 x	10	50/40 x 1 1/2"	
50-40	604160 x	10	63/50 x 2"	

Gewindereduktionen  
Klebe x IG



Typ A



Typ B

DN	Art.-Nr.	VE	DA x IG	Preis
15	610850 x	10	20 x 1/4"	
15	610860 x	10	20 x 3/8"	
20	610870 x	10	25 x 3/8"	
20	610880 x	10	25 x 1/2"	
25	610890 x	10	32 x 1/2"	
25	610900 x	10	32 x 3/4"	
32	610901 x	10	40 x 1/2"	
32	610910 x	10	40 x 3/4"	
32	610920 x	10	40 x 1"	
40	610923 x	10	50 x 1/2"	
40	610921 x	10	50 x 3/4"	
40	610922 x	10	50 x 1"	
40	610930 x	10	50 x 1 1/4"	
40	610940 Typ B x	10	50 x 1 1/2"	
50	610941 x	10	63 x 1 1/4"	
50	610950 x	10	63 x 1 1/2"	
50	610960 Typ B x	10	63 x 2"	

Behälterverschraubungen

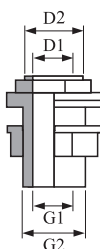
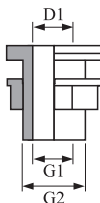

G1	G2	Art.-Nr.	VE	D1 x G1	Preis
3/8"	3/4"	608000 x	10	16 x 3/8"	
1/2"	1"	608010 x	10	20 x 1/2"	
3/4"	1"	608020 x	10	20 x 3/4"	
1"	1 1/4"	608030 x	10	25 x 1"	
1 1/2"	2"	608040 x	10	40 x 1 1/2"	
2"	2 3/4"	608050 x	10	63 x 2"	

G1	G2	Art.-Nr.	VE	D1 x D2	Preis
50	63	533478 x	45	50 x 2"	
50	63	533420 x	45	50 x 2 1/4"	
63	75	533430 x	25	63 x 2 1/2"	
75	90	533440 x	24	75 x 3"	
90	110	533450 x	10	90 x M 113	



Bitte beachten!  
x = PN 10





**PVC-FITTINGE - PN 16 - IBG**



Farbe dunkelgrau RAL 7011

Verschraubungen  
Klebemuffe x Klebemuffe



DN	Art.-Nr.	O-Ring: EPDM		Preis
		VE	DA	
15	600030	90	20	
20	650030	10	25	
25	650040	10	32	
32	500150	100	40	
40	500160	32	50	
50	500170	20	63	

Verschraubungen  
Klebemuffe x IG



DN	Art.-Nr.	O-Ring: EPDM		Preis
		VE	DA x IG	
15	600110 x	10	20 x 1/2"	
20	654800 x	10	25 x 3/4"	
25	654810 x	10	32 x 1"	
32	654820 x	10	40 x 1 1/4"	
40	654830 x	2	50 x 1 1/2"	
50	654840 x	2	63 x 2"	

Verschraubungen  
Klebemuffe x AG



DN	Art.-Nr.	O-Ring: EPDM		Preis
		VE	DA x AG	
15	533110 x	10	20 x 1/2"	
20	533120 x	10	25 x 3/4"	
25	533130 x	10	32 x 1"	
32	533140 x	10	40 x 1 1/4"	
40	650090 x	10	50 x 1 1/2"	
50	533150 x	2	63 x 2"	

Übergangverschraubungen  
Klebemuffe x AG mit O-Ring



DN	Art.-Nr.	VE	DA x AG	Preis
40	500260 x	40	50 x 1 1/2"	
40	500400	10	50 x 2"	
50	500270 x	35	63 x 2"	

Verschraubungen grau  
Klebe x AG mit O-Ring grau



DN	Art.-Nr.	VE	DA x AG	Preis
80	08085 x	1	90 x 3"	

Reduzierschraubung grau  
Klebemuffe



DN	Art.-Nr.	VE	DA x DA	Preis
40	500200	75	50 x 40/50	



Bitte beachten!  
x = PN 10



## PVC-FITTINGE - PN 16 - IBG

### Übergangverschraubungen - Rotguss Klebhempe x IG



DN	Art.-Nr.	VE	DA x IG	Preis
15	600310	10	20 x 1/2"	
20	600320	10	25 x 3/4"	
25	600330	10	32 x 1"	
32	600340	10	40 x 1 1/4"	
40	600350	10	50 x 1 1/2"	
50	600360	10	63 x 2"	

### Übergangverschraubungen - Rotguss Klebhempe x AG

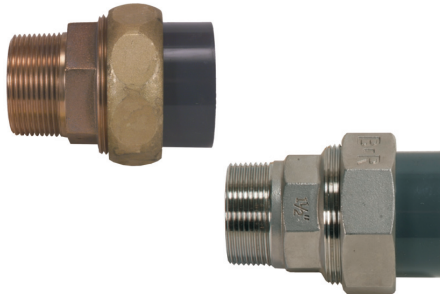

DN	Art.-Nr.	VE	DA x AG	Preis
15	600410	10	20 x 1/2"	
20	600420	10	25 x 3/4"	
25	600430	10	32 x 1"	
32	600440	10	40 x 1 1/4"	
40	600450	10	50 x 1 1/2"	
50	600460	10	63 x 2"	
40	600455 V4A	10	50 x 1 1/2"	
40	13751 V2A	10	50 x 1 1/2"	

## ERSATZTEILE VERSCHRAUBUNGEN - IBG

### Farbe dunkelgrau RAL 7011 Einlegeteil - PVC



DN	Art.-Nr.	VE	DA	Preis
20	654620	10	25	
25	654630	10	32	
32	654640	10	40	
40	654650	10	50	
50	654660	10	63	

### Einschraubteil PVC



DN	Art.-Nr.	VE	DA	Preis
20	654720	10	25	
25	654730	10	32	
32	654740	10	40	
40	654750	10	50	
50	654760	10	63	

### O-Ringe - EPDM für Verschraubungen PVC



DN	Art.-Nr.	VE	DA	Preis
15	607510	100	20	
20	607520	100	25	
25	607530	100	32	
32	607540	100	40	
40	540010	100	50	
50	540020	100	63	

### Flach-Dichtring - EPDM für Bundbuchsen



D-mm	Art.-Nr.	VE	DA	Preis
27	606200	10	16	
32	606210	10	20	
39	606220	10	25	
48	606230	10	32	
59	606240	10	40	
71	606250	10	50	
88	606260	10	63	

## ROHRKLEMMEN - PRAHER

€ **Gruppe A**  
exkl. MWSt.

**Rohrklemme Typ Praher**  
aus Polypropylen  
(VE = 20 Stück verpackt)



Dim.	NW	Art.-Nr.	VE	DA	Preis
16-19 mm	10	08000	20	16	
20-23 mm	16	08001	20	20	
25-28 mm	20	08002	20	25	
31-35 mm	25	08003	20	32	
39-43 mm	32	08004	20	40	
47-51 mm	40	08005	500	50	
60-65 mm	50	08006	300	63	
72-80 mm	63	08007	10	75	
87-95 mm	75	08008	10	90	

## ROHRKLEMMEN PP - CEPEX

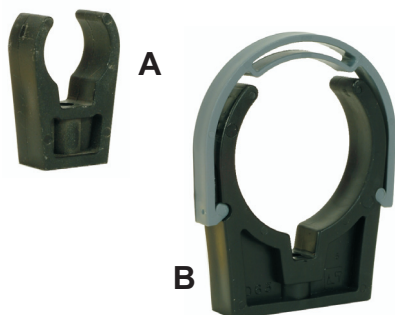

Typ	Art.-Nr.	DN	DA	VE	Preis
A	402132	16	20	150	
A	402133	20	25	110	
A	402134	25	32	90	
A	402135	32	40	100	
B	402140	40	50	110	
B	402141	50	63	70	
B	402142	63	75	90	
B	402143	75	90	54	
B	408916	90	110	20	
B	408917	100	125	18	
B	410956	110	140	13	
B	408918	140	160	10	
B	410958	200	225	6	

## MAUERKRAGEN FÜR ROHRDURCHFÜHRUNG EPDM

**Abdichtungswirkung bis 60 m WS**, Mauerkragen-Montageset beinhaltet 1 Mauerkragen und 2 Edelstahl-Spannbänder  
(auf die Dimension abgestimmt)

€ **Gruppe B**  
exkl. MWSt.

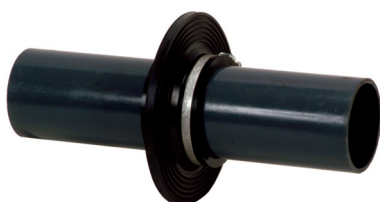

Rohr-D	D-Bereich	Art.-Nr.	D1(mm)	L1(m)	Preis
Aussen	Aussen				
DA 32	32-36	16102	29	0,45	
DA 40	40-44	16103	38	0,5	
DA 50	50-55	16104	48	0,6	
DA 63	63-69	16105	60	0,7	
DA 75	75-82	16106	71	0,8	
DA 90	90-97	16107	84	0,9	
DA 110	110-121	16108	105	1,0	
DA 125	125-140	16109	120	1,1	
DA 140	125-140	16110	120	1,2	
DA 160	160-170	16111	154	1,3	
DA 225	225-240	16114	215	2,1	
DA 280	280-290	16116	275	2,5	
DA 315	315-330	16117	310	2,6	

## PVC-DRUCKROHRE PN 10 / grau gemufft - Stangenware

**Gruppe A**  
exkl. MWSt.

Rohr gemufft



**Achtung: Die Auslieferung von PN10 PVC-Druckrohren grau erfolgt nur in ganzen Stangen!**

Rohrlänge:	DN	Art.-Nr.	VE	DA	Preis/ lfm.
5 lfm	20	402706	1	25	
5 lfm	25	402707	1	32	
5 lfm	32	402708	1	40	
5 lfm	40	402709	1	50	
<hr/>					
2 lfm	40	4027092	1	50	
<hr/>					
3 lfm	40	4027093	1	50	
5 lfm	50	402710	1	63	
3 lfm	50	4027103	1	63	
5 lfm	65	402711	1	75	
5 lfm	80	402712	1	90	
5 lfm	100	402713	1	110	
5 lfm	125	402715	1	140	
5 lfm	150	402716	1	160	
5 lfm	200	402717	1	225	
5 lfm	250	402718	1	280	
5 lfm	300	402719	1	315	
<hr/>					
1 Palette	3 m	DA 50	=	582 lfm	
1 Palette	5 m	DA 50	=	970 lfm	
1 Palette	5 m	DA 63	=	615 lfm	
1 Palette	3 m	DA 63	=	369 lfm	

## PVC-DRUCKROHRE PN 16 / grau gemufft - Stangenware

Rohr gemufft



**Achtung: Die Auslieferung von PN16 PVC-Druckrohren grau erfolgt nur in ganzen Stangen!**

Rohrlänge:	DN	Art.-Nr.	VE	DA	Preis/ lfm.
5 lfm	10	402721	1	16	
5 lfm	15	402722	1	20	
5 lfm	20	402723	1	25	
5 lfm	25	402724	1	32	
5 lfm	32	402725	1	40	
5 lfm	40	402726	1	50	
3 lfm	40	4027263	1	50	
5 lfm	50	402727	1	63	
3 lfm	50	4027273	1	63	
5 lfm	65	402728	1	75	
5 lfm	80	402729	1	90	
5 lfm	100	402730	1	110	
5 lfm	125	402731	1	140	
5 lfm	150	402732	1	160	
5 lfm	200	402733	1	225	
<hr/>					
1 Palette	3 m	DA 50	=	582 lfm	
1 Palette	5 m	DA 50	=	970 lfm	
1 Palette	5 m	DA 63	=	615 lfm	
1 Palette	3 m	DA 63	=	369 lfm	

## PVC-ROHRE PN 10 / transparent ungemufft - Meterware

Rohr ungemufft



Rohrlänge:	DN	Art.-Nr.	VE	DA	Preis/ lfm.
1 lfm	40	16305	1	50	
1 lfm	50	16306	1	63	
1 lfm	65	16307	1	75	
1 lfm	80	16308	1	90	
1 lfm	100	16309	1	110	
1 lfm	125	16310	1	140	
1 lfm	150	16311	1	160	

**Achtung: Die Auslieferung von PN10 PVC-Druckrohren transparent erfolgt nur in ganzen Metern!**

## PVC-ROHR PN 10 / schwarz gemufft - Stangenware

Rohr gemufft

Rohrlänge:	DN	Art.-Nr.	VE	DA	Preis/ lfm.
5 lfm	40	402705	1	50	

**Achtung: Die Auslieferung von PN10 PVC-Druckrohren schwarz erfolgt nur in ganzen Stangen!**



## POOL-PVC-FLEXSCHLAUCH

€ **Gruppe A**  
exkl. MWSt.



Bezeichnung	Art.-Nr.	DA	Rolle	D	d	Preis per 25 lfm.
Flexschlauch	183211	20	25 m	20	16	
Flexschlauch	183221	25	25 m	25	20	
Flexschlauch	183231	32	25 m	32	26	
Flexschlauch	183241	40	25 m	40	34	
Flexschlauch	183251	50	25 m	50	42	
Flexschlauch	183277	50	25 m	50	40	verstärkte Ausführung
Flexschlauch	183261	63	25 m	63	55	
Flexschlauch	183271	75	25 m	75	65	
Flexschlauch	183273	90	25 m	90	80	
40599247	Muffe extra lang DA 50, speziell für Klebeschlauch					
40599248	Muffe extra lang DA 63, speziell für Klebeschlauch					

## POOL-PVC-FLEXKLEBSCHLAUCH - Fitt b-active flex

€ **Gruppe B**  
exkl. MWSt.



Bezeichnung	Art.-Nr.	DA	Rolle	D	Preis per 25 lfm.
Flexschlauch	183285	50	25 m	50	
Flexschlauch	183286	63	25 m	63	



**Achtung: Der Klebeschlauch muss in einem Sandbett verlegt werden! Eine protokollierte Druckprüfung ist vor dem Hinterfüllen und vor der Inbetriebnahme zwingend erforderlich! (EN-Norm)**  
Der Klebeschlauch ist nicht als Leitung zur Wassernachspeisung geeignet!

### BONDITE-Kleber PVC-U mit Pinsel



Gewicht kg	Art.-Nr.	VE	Preis per Stück
0,25 kg Dosen	427050	30 Stk.	
1,00 kg Dosen	427052	12 Stk.	

### GRIFFON-Kleber WDF-05



mit Pinsel-Verschluss

Liter	Art.-Nr.	VE	Preis per Stück
0,25 l Dosen WDF5	538780	12 Stk.	
0,5 l Dosen WDF5	538781	12 Stk.	

Besonders für Klebeschläuche geeignet.  
Auch bei Feuchtigkeit verklebbar!



in Rollen zu 25 m  
Farbe grau  
Kälte- aber nicht frostbeständig!

### Vorteile bei der Verwendung von weich PVC-Schlauch gegenüber PVC- und Rohr:

- einfach zu transportieren
- weniger Fittinge und Klebestellen, da sich der Schlauch der Form anpasst.
- kürzere Montagezeiten
- bis zu 25 m ohne Verbindungsfittinge möglich
- Wandstärke 4 mm



**Achtung: Der Klebeschlauch muss in einem Sandbett verlegt werden, bei unzugänglichen Stellen (z.B. unter gefliesten Betonteilen) empfehlen wir dringend die Verlegung im Doppelrohr! Eine protokollierte Druckprüfung ist vor dem Hinterfüllen und vor der Inbetriebnahme zwingend erforderlich! (EN-Norm)**

## FLEX-FIT die Klemmverbindung für den PVC-Schlauch DA 50



550550	PVC-U-Übergangverschraubung, d 50 Klemm x DA 50 Klebestutze	VE = 30
550650	PVC-U-Übergangverschraubung, d 50 Klemm x DA 50 Klebemuffe	VE = 24
551250	PVC-U-Übergangverschraubung, d 50 Klemm x 1 1/2" IG	VE = 24
550750	PVC-U-Übergangverschraubung, d 50 Klemm x 1 1/2" AG + O-Ring	VE = 25
550700	PVC-U-Übergangverschraubung, d 50 Klemm x 2" AG + O-Ring	VE = 24
551050	PVC-U-Doppelverschraubung, d 50 Klemm x d 50 Klemm	VE = 16







Der Klebeschlauch ist nicht als Leitung zur Wassernachspeisung geeignet!



## FLEX-FIT die Klemmverbindung für den PVC-Schlauch DA 50

€ **Gruppe A**  
exkl. MWSt.

	550960 <b>PVC-U-Übergangswinkel 45°</b> , DA 50 Klebemuffe x d 50 Klemm	VE = 25
	550850 <b>PVC-U-Übergangswinkel 90°</b> , DA 50 Klebemuffe x d 50 Klemm	VE = 25
	550900 <b>PVC-U-Übergangswinkel 90°</b> , D 50 Klemm x 1 1/2" AG	VE = 25
	550950 <b>PVC-U-Übergangswinkel 90°</b> , d 50 Klemm x d 50 Klemm	VE = 10
	550855 <b>PVC-U-Übergangswinkel 90°</b> , DA 50 Klebemuffe x 1 1/2" IG	VE = 25
	550350 <b>PVC-U-Übergangs T-Stück 90°</b> , DA 50 Klebemuffe x d 50 Klemm x DA 50 Klebemuffe	VE = 18
	550450 <b>PVC-U-Übergangs T-Stück 90°</b> , d 50 Klemm x d 50 Klemm x d 50 Klemm	VE = 8
	550460 <b>PVC-U-Übergangs T-Stück 90°</b> , d 50 Klemm x DA 63 x d 50 Klemm	VE = 6
	550470 <b>PVC-U-Übergangs T-Stück 90°</b> , 50 Klemm x d 63 Klemm x d 50 Klemm	VE = 8

## FLEX-FIT die Klemmverbindung für den PVC-Schlauch DA 63

	563550 <b>PVC-U-Übergangsverschraubung</b> , d 63 Klemm x DA 63 Klebestutzen	VE = 25
	563650 <b>PVC-U-Übergangsverschraubung</b> , d 63 Klemm x DA 63 Klebemuffe	VE = 25
	563655 <b>PVC-U-Doppelverschraubung</b> , d 63 Klemm x d 63 Klemm	VE = 18
	563750 <b>PVC-U-Verschraubung</b> , d 63 Klemm x 2" AG + O-Ring	VE = 36
	563755 <b>PVC-U-Verschraubung</b> , d 63 Klemm x 2" IG	VE = 25
	563850 <b>PVC-U-Übergangswinkel 90°</b> , d 63 Klemm x DA 63 Klebemuffe	VE = 25
	563950 <b>PVC-U-Winkel 90°</b> , d 63 Klemm x d 63 Klemm	VE = 10
	563855 <b>PVC-U-Übergangswinkel 90°</b> , d 63 Klemm x 2" IG	VE = 24
	563350 <b>PVC-U-Übergangs-T-Stück</b> , DA 63 Klebemuffe x d 63 Klemm	VE = 16
	563450 <b>PVC-U-T-Stück 90°</b> , d 63 Klemm x d 63 Klemm x d 63 Klemm	VE = 10
	550120 <b>Montageschlüssel Flex-Fit, DA 50</b>	VE = 10
	563120 <b>Montageschlüssel Flex-Fit, DA 63</b>	VE = 10



**Der Klebeschlauch ist nicht als Leitung zur Wassernachspeisung geeignet!**



## ROHRKENNZEICHNUNGSSCHILD MIT AUFKLEBER

### Rohrkennzeichnungsschild

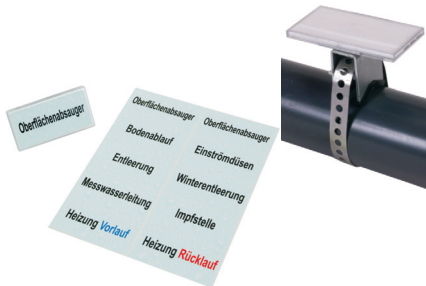

	Art.-Nr.	VE	Preis
Rohrschild	<b>16223</b>	10	

Komplett im Spannband und Kunststoff-Deckel passend für Rohre bis DA 160

28003 **Beschriftungsetiketten, abwaschbar** per Bogen  
in Verbindung mit 16223 oder zum direkten Aufkleben auf Rohre.

## SPEZIALKLEBER FÜR PVC-KLEBSCHLÄUCHE

### BONDITE-Kleber PVC-U mit Pinsel



Gewicht kg		Art.-Nr.	VE	Preis per Stück
0,25 kg	Dosen	<b>427050</b>	30 Stk.	
1,00 kg	Dosen	<b>427052</b>	12 Stk.	

## PVC-KLEBER-CEPEX

### CEPEX-Kleber mit Pinsel - NEU THF frei!



mit Pinsel-Verschuß  
mit Pinsel-Verschuß  
mit Pinsel-Verschuß

Gewicht kg		Art.-Nr.	VE	Preis per Stück
0,125 kg	Tube	<b>4024290</b>	30 Stk.	
0,25 kg	Dosen	<b>4024300</b>	28 Stk.	
0,50 kg	Dosen	<b>4090430</b>	15 Stk.	
1,00 kg	Dosen	<b>4090440</b>	12 Stk.	

### TANGIT-Kleber



Gewicht kg		Art.-Nr.	VE	Preis per Stück
0,125 kg	Tube	<b>16219</b>	12 Stk.	
0,50 kg	Dosen	<b>16221</b>	12 Stk.	
1,00 kg	Dosen	<b>16220</b>	6 Stk.	

### SABA-Kleber S 3



mit Pinsel-Verschuß  
mit Pinsel-Verschuß

Liter		Art.-Nr.	VE	Preis per Stück
0,25 l	Dosen	<b>537650</b>	24 Stk.	
1,00 l	Dosen	<b>537660</b>	12 Stk.	



**Bitte beachten Sie**, dass aufgrund des nationalen Gefahrgutbeförderungsgesetzes (GGBG) und den internationalen Gefahrgutvorschriften für den Strassentransport (ADR) die Lieferung von Chlor- und allen anderen Gefahrgütern (z.B.: Schwimmbadchemikalien, Kleber etc...) nur noch in Verpackungseinheiten erfolgen kann. Die Rücknahme von Chlor- und allen anderen Gefahrgütern (z.B.: Schwimmbadchemikalien, Kleber etc.) ist Aufgrund der oben genannten gesetzlichen Regelungen nur in geschlossenen Originalverpackungen möglich.  
**Die Rücknahme von bereits geöffneten Verpackungen und/oder Einzelgebänden ist ausnahmslos nicht möglich!**

**PVC-KLEBER-REINIGER / TANGIT / SABA / GRIFFON**



**GRIFFON-Kleber UNI 100**



mit Pinsel-Schnell-Verschluss  
mit Pinsel-Schnell-Verschluss  
mit Pinsel-Schnell-Verschluss

Liter		Art.-Nr.	VE	Preis per Stück
0,25 l	Dosen	<b>538750A</b>	24 Stk.	
0,50 l	Dosen	<b>538760A</b>	12 Stk.	
1,00 l	Dosen	<b>538770A</b>	8 Stk.	

**Achtung: nur zum Kleben von PVC.**

mit Pinsel-Schnell-Verschluss

0,25 l	Dosen WDF5	<b>538780</b>	12 Stk.	
0,50 l	Dosen WDF5	<b>538781</b>	12 Stk.	

**Besonders für Klebeschläuche geeignet.  
Auch bei Feuchtigkeit verklebbar!**

**PVC-REINIGER TANGIT / GRIFFON**



Liter		Art.-Nr.	VE	Preis per Stück
0,125 l	Tangit	<b>16224</b>	20 Stk.	
0,50 l	Griffon	<b>538670</b>	12 Stk.	
1,00 l	Tangit	<b>16225</b>	12 Stk.	
0,125 l	Cepex	<b>402433</b>	28 Stk.	
0,50 l	Cepex	<b>402432</b>	15 Stk.	
1,00 l	Cepex	<b>402431</b>	12 Stk.	

**TEFLONDICHTBAND**



Rolle	Art.-Nr.	VE	Preis per Stück
spezial	<b>402435</b>	10 Stk.	

538795 **Kolmat Dichtband**



- für alle Gewindeverbindungen geeignet
- Metall, Kunststoff oder in Kombination miteinander
- geeignet für Wasser, Dampf, Gas, Druckluft, etc.
- belastbar bis 160°C und 26 bar
- leicht und schnell anzubringen
- saubere Verarbeitung
- füllt Spaltmaße und Toleranzen perfekt aus
- passt sich allen Gewindeformen an
- zurückdrehen >180°
- direkt belastbar und demontierbar
- eine perfekte Verbindung, 100% dicht



Bitte beachten Sie, dass aufgrund des nationalen Gefahrgutbeförderungsgesetzes (GGBG) und den internationalen Gefahrgutvorschriften für den Strassentransport (ADR) die Lieferung von Chlor- und allen anderen Gefahrgütern (z.B.: Schwimmbadchemikalien, Kleber etc...) nur noch in Verpackungseinheiten erfolgen kann. Die Rücknahme von Chlor- und allen anderen Gefahrgütern (z.B.: Schwimmbadchemikalien, Kleber etc.) ist aufgrund der oben genannten gesetzlichen Regelungen nur in geschlossenen Originalverpackungen möglich.  
**Die Rücknahme von bereits geöffneten Verpackungen und/oder Einzelbinden ist ausnahmslos nicht möglich!**

## GRIFFON ZUBEHÖR



538801 **Kabelsäge**

€ **Gruppe A**  
exkl. MWSt.

## UNIVERSAL LEITUNGS-PRÜFSTOPFEN

- aus verzinktem Stahl mit Gummibalg
- Spannvorrichtung mit Stahl-Flügelmutter
- Verschlusskappe mit Dichtung 1/2"
- speziell für Leitungsprüfung bis 3,5 bar lt. EN-NORM 16713

€ **Gruppe B**  
exkl. MWSt.



32160 **Leitungs-Prüfstopfen für Rohre DA40 und DA50  
von D 36 mm bis D 48 mm**



32161 **Leitungs-Prüfstopfen für Rohr DA63  
von D 49 mm bis D 60 mm**



32162 **Leitungs-Prüfstopfen für Rohr DA75  
von D 62 mm bis D 75 mm**

32163 **Leitungs-Prüfstopfen für Rohr DA90  
von D 73 mm bis D 85 mm**



32164 **Leitungs-Prüfstopfen für Rohr DA110  
von D 94 mm bis D 108 mm**

32167 **Abdruckarmatur, Anschluss 1/2" I.G.  
mit Absperrhahn, Manometer und  
Gardena-Schlauchanschluss**

